

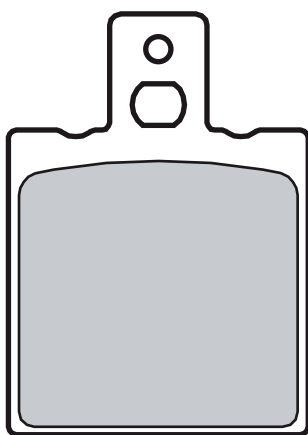

07BB01.SP	39,8x56,2x 6,8
07BB01.06	" " "
07BB01.35	" " "
GENUINE	

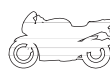

2

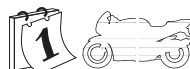
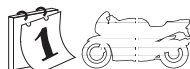
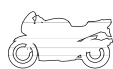

ALFER

250 MC	87	•
--------	----	---

APRILIA

50 RS	93 > 95	•
50 RS	96 > 99	•
125 AF1	86	•
125 AF1 FUTURA, EUROPA	89 > 91	•
125 AF1 REPLICA, SINTESI	88 > 89	•
125 RS, EXTREMA	93 > 98	•
125 TUAREG RALLY	89	•
125 TUAREG WIND	89	•
350 RALLY	86	•
350 WIND	87	•

BENELLI

125 2CTURISMO, SPORT		•
500 504 SPORT	76	•
650 654	83	•
650 654 SPORT	83	•

BIMOTA

400 YB 7	94	•
600 BELLARIA	90 > 92	•
600 BELLARIA	93	•
600 YB 9 SR, SRI	97	•
750 YB 4	88	•
851 TESI	91	•
900 DB2	93	•
900 DB2 SR	94	•
906 TESI	91	•
1000 DB 1	87	•
1000 DB 1	91	•
1000 DB 1 RS	87	•
1000 FURANO	92	•

1000 TUATARA	90	•
1000 YB 6	87	•
1000 YB 8	89	•
1100 SB6	94	•
1200 YB 5 FS	87	•

CAGIVA

50 LUCKY EXPLORER	88	•
50 W4	92	•
80 COCIS	91	•
80 W4	92	•
125 CROSS	84 > 87	•
125 ELEFANT 3	86	•
125 FRECCIA C10	88 > 89	•
125 FRECCIA C10 ANNIV.	89	•
125 FRECCIA C12	89	•
125 FRECCIA C9	88	•
125 MITO	90	•
125 MITO 2	92 > 93	•
125 MITO 525	08	•
125 MITO EURO2	04	•
125 MITO EV	94 > 03	•
125 PLANET	98 > 00	•
125 RAPTOR	03	•
125 RAPTOR	05	•
125 W8	92 > 98	•
190 VMX	82	•
250 SST	81	•
250 SXT	83	•
350 ALA ROSSA	83	•
350 ELEFANT	85	•
350 SST	80	•
350 SXT	83	•
350 T4, T4 R	87	•
500 RIVER	99	•

500 T4 E, R	87	•
600 RIVER	94	•
650 ALA AZZURRA	85	•
650 ELEFANT	85 > 87	•
750 ELEFANT	87	•

DUCATI

350 XL	82	•
400 MONSTER 400	03 > 04	•
500 PANTAH	77	•
600 PANTAH	81	•
650 INDIANA	86	•
748 748	00 > 02	•
748 748 BIPOSTO	98	•
748 748 BIPOSTO	99	•
748 748 R	00	•
748 748 R	01 > 02	•
748 748 S	00 > 02	•
748 748 SPS	98 > 99	•
750 PASO	87 > 88	•
851 851	89	•
851 851 SP2	90	•
851 851 SP3 / 851 SUPERBIKE	91	•
888 888 RACING	92	•
900 SUPERSPORT 900	90 > 97	•
916 916	94 > 96	•
916 916 BIPOSTO, SENNA	94 > 98	•
916 916 S, 916 SP	94 > 96	•
916 916 SPS	97	•
916 916 SPS	98	•
996 996 R	01	•
996 996, 996 S	01	•
996 996, 996 S, 996 SPS, 996 SPS III	00	•
996 996, 996 SPS, 996 SPS II	99	•
996 MONSTER S4 R	03	•





998	998	02	•
998	998 F.E.	04	•
998	998 Matrix	04	•
998	998 R	02	•
998	998 S	02	•

FRIGERIO PUCH

125	F7	89	•
125	REPLAY	89	•
250	CROSS	84 > 85	•
250	REPLAY	89	•
350	HV	0	•

GILERA

125	CROSS	84 > 85	•
125	MXR	90	•
125	RX	83	•
200	RX	85	•
250	ARIZONA RALLY	0	•
250	CROSS	83	•
250	NGR	85	•

HONDA

125	NSR, F	88 > 89	•
-----	--------	---------	---

HUSQVARNA

125	CR	84 > 86	•
240	CR	84 > 85	•
250	CR	84 > 86	•
250	CX	84 > 85	•

KRAMIT

125	SCRAMBLER	0	•
-----	-----------	---	---

LAVERDA

125	LZ	82	•
125	LZ (CU)	85	•
125	SP	82	•
125	ST	82	•
350	350	77	• •
500	500	77	• •
600	ATLAS	86	•

MOTO GUZZI

350	350	77	• •
350	NTX	88 > 89	•
350	NTX	90	•
350	V 35	84	• •
350	V 35 FLORIDA	87	•
350	V 35 II	84	• •
350	V 35 IMOLA	84	• •
350	V 35 POLIZIA	84	• •
350	V 35 TT	84	• •
500	V 50 C	80	• •
500	V 50 III	85	• •
500	V 50 MONZA	84	• •
500	V 50 POLIZIA	80	• •
650	NTX	87	•
650	V 65	86	•
650	V 65 FLORIDA, LARIO	87	•
750	TARGA	89	•
1000	DAYTONA	92 > 95	•
1000	DAYTONA RACING	92 > 96	•
1000	DAYTONA RS	97 > 98	•
1000	V10 CENTAURO	97 > 99	•
1100	CALIFORNIA EV	01 > 05	•
1100	SPORT	94 > 96	•

1100	SPORT CORSA	98 > 99	•
1100	SPORT INIEZIONE	96 > 99	•
1100	V11 CAFE SPORT/BALLABIO	03	•
1100	V11 COPPA ITALIA	04	•
1100	V11 LE MANS	01	•
1100	V11 LE MANS/NAKED	03	•
1100	V11 LE MANS/NAKED/SPORT	01 > 02	•
1100	V11 SCURA	02	•
1100	V11 SPORT ROSSO	01	•

MOTO MORINI

350	DART	87	•
350	DART	88 > 89	•
350	EXCALIBUR	87	•
400	DART	89 > 89	•
400	DART	90	•
501	COGUARO	89	•
501	EXCALIBUR	89 > 89	•
501	EXCALIBUR	90	•

SWM

500	4 T	0	•
-----	-----	---	---



07BB02.SD	77,9x41,2x	9
07BB02.SX	" "	"
07BB02.TT	" "	"
07BB02.25	" "	"
GENUINE		
07BB02.30	" "	"
GENUINE		
07BB02.35	" "	"
GENUINE		
07BB02.58	" "	"
GENUINE		
07BB02.65	" "	"
GENUINE		

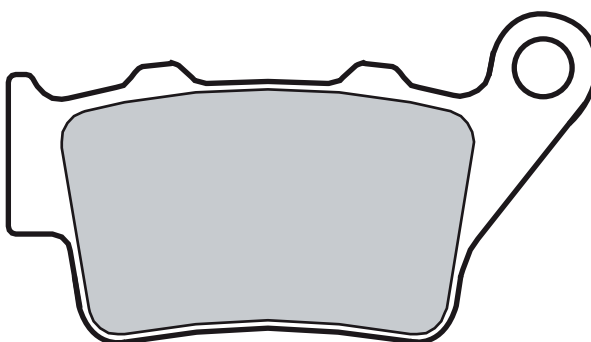

2



ALFER

125 VRE - 4 STROKE	00	•
250 VR CROSS	99	•
250 VR ENDURO	99	•
250 VR NO LIMIT	99	•
250 VR SUPERMOTARD	99	•

APRILIA

650 PEGASO	04	•
650 PEGASO I.E.	01	•
650 PEGASO STRADA	05	•
650 PEGASO TRAIL	06	•
660 PEGASO STRADA FACTORY	05	•
750 DORSODURO 750	09	•
750 DORSODURO 750 ABS	09	•
750 SHIVER	07	•
750 SHIVER 750	09	•
750 SHIVER 750 ABS	09	•
750 SHIVER 750 GT ABS	09	•
750 SHIVER 750 GT	09	•
750 SMV DORSODURO	08	•
750 SMV DORSODURO	08 > 08	•
850 MANA	07 > 07	•

BENELLI

449 BX Cross	07	•
449 BX Supermotard	08	•
505 ENDURO	08	•

BETA

125 JONATHAN	99	•
--------------	----	---

350 EURO	99	•
350 JONATHAN	02	•

BMW

450 ENDURO	08	•
650 F 650 GS	01	•
650 F 650 GS DAKAR	01 > 07	•
650 F 650 GS RALLY	01	•
650 F 650, CS	02 > 06	•
650 F 650, ST	93 > 00	•
650 G 650 Xchallenge	07	•
650 G 650 Xcountry	07	•
650 G 650 Xmoto	07	•
800 F 650 GS	08	•
800 F 800 GS	08	•
800 F 800 S	06	•
800 F 800 S, R	09	•
800 F 800 ST	06	•

CCM

600 RS	01	•
600 SPORT	99	•
600 SUPERMOTO	99	•
644 DS	02	•
644 R30	02	•

DUCATI

992 GT 1000	07	•
992 PAUL SMART 1000 L.E.	05	•
992 SPORT 1000	05 > 06	•
992 SPORT 1000 (biposto)	07	•

992 SPORT 1000 (monoposto)	07	•
992 SPORT 1000 S	07	•
1000 GT 1000 TOURING	09	•

GAS GAS

125 EC	97 > 99	•
200 EC	99	•
250 EC	97 > 99	•
250 MC	97 > 99	•
300 EC	99	•

HIGHLAND

450 MX	06	•
950 V2	99	•

HONDA

500 CB	97	•
500 CB S	98	•
650 NX DOMINATOR	97	•
650 SLR	97	•
650 VIGOR	99 > 02	•

HRD

50 GS ENDURO	00	•
--------------	----	---

HUSABERG

400 FC	99	•
400 FE	99	•
400 FS SUPERMOTARD	01	•
450 FC	03	•
450 FC (cross)	05	•





450 FE (enduro)	05	•
450 FE E	04	•
450 FSC SUPERMOTARD	03	•
450 FSE SUPERMOTARD	03	•
450 FX	03	•
470 FC	01	•
470 FX	01	•
550 FC	01	•
550 FC (cross)	05	•
550 FE (enduro)	05	•
550 FE E	04	•
600 FE, FC	99	•
650 FE (enduro)	05	•
650 FSC SUPERMOTARD	01	•
650 FSE SUPERMOTARD	01	•
650 FX	01	•

HUSQVARNA

125 CR	03 > 04	•
125 CR	95 > 98	•
125 CR	99 > 02	•
125 SM	98	•
125 SMS	00 > 01	•
125 SMS	05	•
125 WR	03 > 04	•
125 WR	95 > 97	•
125 WR	98 > 02	•
125 WR E	06	•
125 WR E	94 > 98	•
125 WR E	98 > 05	•
250 CR	01	•
250 CR	02 > 04	•
250 CR	95 > 98	•
250 CR	99 > 00	•
250 TC	02 > 03	•
250 TE	03	•
250 TE	04	•
250 WR	01	•
250 WR	02	•
250 WR	95 > 97	•
250 WR	98 > 00	•
350 TE	95	•
360 WR	01	•
360 WR	02	•
360 WR	95 > 98	•
360 WR	98 > 00	•
400 SM R	02	•
400 TE	01	•
410 TE	95 > 98	•
410 TE	99 > 00	•
410 TE E	00 > 01	•

450 SMR	03 > 04	•
450 SMR	05	•
450 TC	03 > 03	•
450 TE	03 > 03	•
450 TE	04 > 05	•
510 SMR	05	•
510 TC	02 > 04	•
510 TE	05	•
510 TE R	04	•
570 NOX	01 > 03	•
570 R	01	•
570 SMR	01	•
570 SMR	02	•
570 SMR	03 > 04	•
570 SMR R	04	•
570 TC	02	•
570 TE	01 > 04	•
610 LT	00	•
610 SM	05	•
610 SM	98 > 99	•
610 SMS	00 > 01	•
610 SMS	03 > 04	•
610 SMS	06	•
610 TC	96 > 97	•
610 TC	98	•
610 TC	99 > 00	•
610 TE	96 > 97	•
610 TE	98	•
610 TE	99 > 00	•
610 TE E	00 > 01	•
610 TE E	03 > 04	•
610 TE E	98	•
610 TE E	99	•
610 TE E DUAL PURPOSE	06	•
610 TE E LT	00	•
610 TE E LT	99	•
630 SMR	04	•

HYOSUNG

450 RX SM	08	•
-----------	----	---

KRAMIT

250 GS, MX, SM	97	•
250 SMR	00	•

KTM

125 EGS	94 > 97	•
125 EGS	98	•
125 EGS	99	•
125 EXC	00	•
125 EXC	01 > 03	•

125 EXC	94 > 97	•
125 EXC	98	•
125 EXC	99	•
125 EXE	00 > 01	•
125 LC2	96 > 98	•
125 STING	99	•
125 SUPERMOTO	00 > 01	•
125 SX	01 > 03	•
125 SX	94 > 97	•
125 SX	98	•
125 SX	99 > 00	•
125 SXS	01 > 02	•
200 EGS	98	•
200 EGS	99	•
200 EXC	01 > 03	•
200 EXC	98	•
200 EXC	99 > 00	•
200 MXC	01 > 03	•
200 MXC	98	•
200 MXC	99 > 00	•
250 EGS	94 > 98	•
250 EGS	99	•
250 EXC	01 > 03	•
250 EXC	94 > 98	•
250 EXC	99 > 00	•
250 EXC RACING	03 > 04	•
250 GS	94 35	•
250 MXC	00	•
250 MXC	01	•
250 SX	01 > 02	•
250 SX	94 > 98	•
250 SX	99 > 00	•
250 SXS	01	•
300 EGS	94 > 98	•
300 EGS	99	•
300 EXC	01 > 03	•
300 EXC	94 > 98	•
300 EXC	99 > 00	•
300 MXC	01 > 03	•
300 MXC	97 > 98	•
300 MXC	99 > 00	•
300 SX	94	•
350 EXC	94	•
360 EGS	96 > 97	•
360 EXC	96 > 97	•
360 MXC	97	•
360 SX	96 > 97	•
380 EGS	98	•
380 EGS	99	•
380 EXC	00	•
380 EXC	01 > 02	•





380	EXC	98	•
380	EXC	99	•
380	MXC	00	•
380	MXC	01	•
380	MXC	98	•
380	MXC	99	•
380	SX	01 > 02	•
380	SX	98	•
380	SX	99 > 00	•
400	DUKE	94 > 95	•
400	EGS	94 > 97	•
400	EXC	00	•
400	EXC	01 > 02	•
400	EXC	94 > 96	•
400	LC4	98 > 01	•
400	MXC	02	•
400	SUPERMOTO	01	•
400	SX	01 > 02	•
400	SX	98	•
400	SX	99 > 00	•
400	SXC	97	•
440	SX	94	•
450	EXC	03	•
450	MXC	03	•
450	SX	03 > 03	•
520	EXC	00	•
520	EXC	01 > 02	•
520	MXC	01 > 02	•
520	SX	00	•
520	SX	01 > 02	•
525	EXC	03	•
525	MXC	03	•
525	SX	03	•
540	SXC	99	•
540	SXS	01 > 02	•
550	MXC	96	•
620	DUKE	94 > 97	•
620	EGS	94 > 97	•
620	EGS ADVENTURE	97	•
620	EXC	94	•
620	LC4	98 > 99	•
620	LC4 RALLY DAKAR	97	•
620	SC	01	•
620	SUPERMOTO	01	•
620	SX	94 > 97	•
620	SX	98	•
620	SX	99	•
620	SXC	97	•
625	SC	02	•
625	SMC	05	•
625	SUPERMOTO	02	•

625	SXC	03	•
640	ADVENTURE	06	•
640	ADVENTURE	98 > 02	•
640	ADVENTURE TRAVELLER'S ED.	07	•
640	DUKE	98	•
640	DUKE II	05 > 07	•
640	DUKE II	99 > 04	•
640	LC4	05	•
640	LC4	98 > 04	•
640	LC4 ADVENTURE	03 > 04	•
640	LC4 ADVENTURE	05	•
640	LC4 ENDURO	03 > 05	•
640	LC4 ENDURO	06	•
640	LC4 RALLY DAKAR	97	•
640	LC4 SUPERMOTO	00 > 02	•
640	LC4 SUPERMOTO	03 > 04	•
640	LC4 SUPERMOTO	05	•
660	LC4 RALLY	00 > 02	•
660	LC4 RALLY	99	•
660	LC4 RALLY DAKAR	97	•
660	RALLY FACTORY REPLICA	03	•
660	SM FACTORY	02	•
660	SM FACTORY REPLICA	03	•
660	SMC	03	•
660	SMC	06	•
660	SMS	07	•
690	DUKE	08	•
690	ENDURO	08	•
690	LC4 690 ENDURO	09	•
690	LC4 690 ENDURO R	09	•
690	SMC	08	•
690	SUPERMOTO	07	•
690	SUPERMOTO PRESTIGE	07	•
950	ADVENTURE S	03	•
950	DUKE	03	•
950	LC8 RALLYE	02	•
990	LC8 990 SUPER DUKE R	09	•
990	SUPER DUKE	05	•
990	SUPER DUKE	06	•
990	SUPER DUKE R	07	•

MACAL

250	CROSS, ENDURO	99	•
500	CROSS, ENDURO	99	•
500	SUPERMOTARD	99	•

TM

80	CROSS	96	•
125	125	96 > 00	•
125	CROSS, ENDURO	91	•
250	E	95 > 00	•

250	E 4-stroke	00	•
300	300	98 > 00	•
320	320	96	•
400	4T	00	•
530	SMM BLACK DREAM	04	•

VERTEMATI

500	CROSS	02	•
501	ENDURO	02	•
501	SUPERMOTARD	02	•

VOR

400	CROSS	00 > 01	•
400	EN	02	•
400	MX	02	•
400	SM	02	•
450	EN	02	•
450	MX	02	•
450	SM	02	•
500	CROSS 495	99	•
500	ENDURO 492	99	•
500	SUPERMOTARD 492	00 > 01	•
530	EN	02	•
530	MX	02	•
530	SM	02	•

YAMAHA

125	YBR	06 > 07	35
600	TT 600	97	•
600	TT 600 R	97	•
660	MT-03	06	•
660	XT R	04	•
660	XT X	04	•
660	XT Z Ténéré	08	•





07BB03.SA	108,5x40,1x7,6
07BB03.SP	" " "
07BB03.06	" " "
07BB03.3A	" " "
GENUINE	
07BB03.35	" " "
GENUINE	
07BB03.48	" " "
GENUINE	
07BB03.59	" " "
GENUINE	
07BB03.65	" " "
GENUINE	
07BB03.73	" " "
GENUINE	
07BB03.90	" " "
GENUINE	

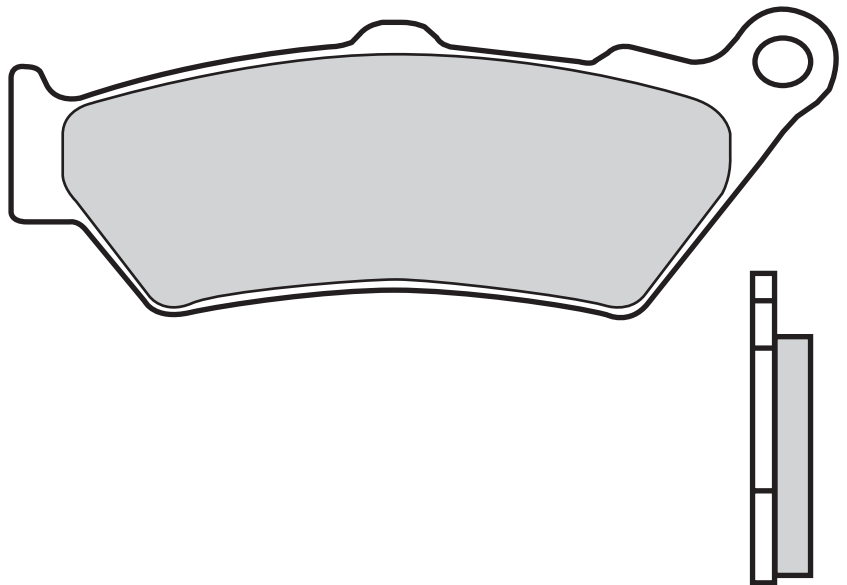

2

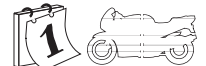
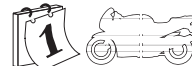
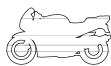
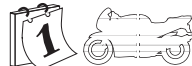
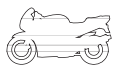

APRILIA

650 MOTO	95	•
650 PEGASO	04	•
650 PEGASO	97 > 03	•
650 PEGASO I.E.	01	•
650 PEGASO TRAIL	06	•
1000 ETV CAPO NORD	01 > 03	•
1000 ETV CAPO NORD ABS	04	•
1000 ETV CAPO NORD RALLY RAID	04	•

BMW

650 F 650 GS	01	•
650 F 650 GS DAKAR	01 > 07	•
650 F 650 GS RALLY	01	•
650 F 650, CS	02 > 06	•
650 F 650, ST	93 > 00	•
650 G 650 Xchallenge	07	•
650 G 650 Xcountry	07	•
800 F 650 GS	08	•
800 F 800 GS	08	•
1200 HP2 ENDURO	06	•

DUCATI

992 GT 1000	07	•
992 PAUL SMART 1000 L.E.	05	•

992 SPORT 1000	05 > 06	•
992 SPORT 1000 (biposto)	07	•
992 SPORT 1000 (monoposto)	07	•
992 SPORT 1000 S	07	•
1000 GT 1000 TOURING	09	•

HONDA

500 CB	97	•
500 CB S	98	•
650 NTV DEAUVILLE	01 > 02	•
650 NTV DEAUVILLE	98 > 00	•
650 NX DOMINATOR	97	•
650 VIGOR	99 > 02	•

KTM

640 ADVENTURE	06	•
640 ADVENTURE TRAVELLER'S ED.	07	•
640 LC4 ADVENTURE	05	•
690 ENDURO	08	•
690 LC4 690 ENDURO	09	•
690 LC4 690 ENDURO R	09	•
950 ADVENTURE	03	•
950 ADVENTURE S	03	•
950 SUPER ENDURO	07	•
950 SUPER ENDURO R	06	•

990 ADVENTURE	06	•
990 ADVENTURE S	06	•

MOTO GUZZI

940 CUSTOM 940 BELLAGIO	07	•
1100 CALIFORNIA ALL., TITANIUM	03	•
1100 CALIFORNIA CLASSIC, TOURING	06	•
1100 CALIFORNIA EV	06	•
1100 CALIFORNIA EV	97 > 00	•
1100 CALIFORNIA EV TOURING	04	•
1100 CALIFORNIA EV, EV TOURING	03	•
1100 CALIFORNIA EV, SPORT	01 > 02	•
1100 CALIFORNIA JACKAL	99 > 01	•
1100 CALIFORNIA JACKAL BASIC	00	•
1100 CALIFORNIA JACKAL BASIC	01	•
1100 CALIFORNIA SPECIAL	01	•
1100 CALIFORNIA SPECIAL	99 > 00	•
1100 CALIFORNIA SPECIAL SPORT	02	•
1100 CALIFORNIA SPECIAL SPORT/ALL.	02	•
1100 CALIFORNIA STONE	01 > 05	•
1100 CALIFORNIA STONE, METAL	02	•
1100 CALIFORNIA VINTAGE	07	•
1100 QUOTA ES	99 > 01	•





2

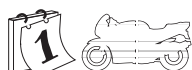

MOTO MORINI

1200 GRANPASSO	08	•
1200 SCRAMBLER	09	•

TM

125 ENDURO	05	•
125 MX	06	•
250 ENDURO	05	•
250 F	05	•

250 F ENDURO	05	•
250 MX	06	•
300 MX	05	•

TRIUMPH

1500 THUNDIRBIRD	09	•
1600 THUNDERBIRD 1600	09	•
2294 ROCKET III CLASSIC	09	•
2294 ROCKET III TOURING / TOURING ABS	09	•

2294 ROCKET III / ROCKET III ABS	09	•
2300 ROCKET III	04	•
2300 Rocket III CLASSIC	07	•

YAMAHA

125 DT X SUPERMOTARD	05	•
660 XT R	04	•



07BB04.12 94x 36,2x 7,6
GENUINE

07BB04.23 " " "
GENUINE

07BB04.35 " " "
GENUINE

07BB04.78 " " "
GENUINE

07BB04.83 " " "
GENUINE

07BB04.84 " " "
GENUINE

07BB04.SA 94x 36,2x 8

07BB04.SP " " "

07BB04.SD " " "

07BB04.SX " " "

07BB04.TT " " "

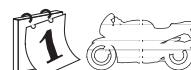
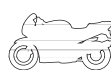
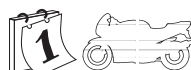
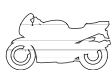
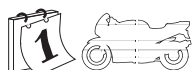
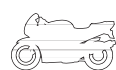
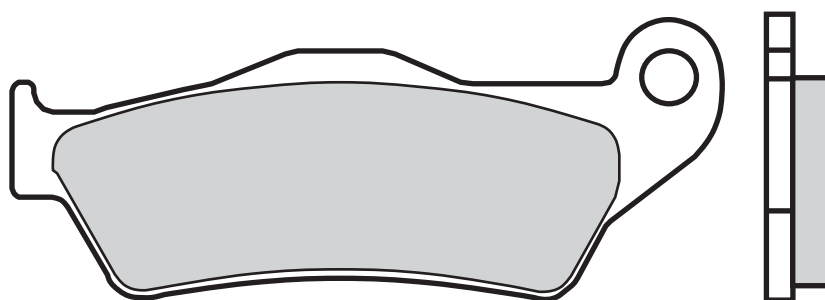

ALFER

125 VRE - 4 STROKE	00	•
250 VR CROSS	99	•
250 VR ENDURO	99	•
250 VR NO LIMIT	99	•
250 VR SUPERMOTARD	99	•

APRILIA

125 MX SUPERMOTARD	04	•
125 MX SUPERMOTO	07	•
125 RX	96	•
125 RX ENDURO	08	•
125 RX SUPERMOTARD	08	•
125 SX	08	•

650 PEGASO	96	•
1000 RST FUTURA	01 > 04	•

BENELLI

449 BX CROSS	07	•
505 ENDURO	08	•



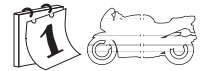
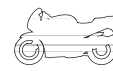
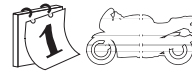
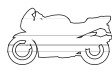
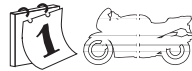
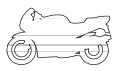

BMW

450 ENDURO	08	•
450 G 450 X	09	•
1200 HP2 ENDURO	06	•
1200 HP2 Sport	08	•

CAGIVA

900 ELEFANT	93	• •
-------------	----	-----

CCM

450 ENDURO	08	•
600 RS	01	•
600 SPORT	99	•
600 SUPERMOTO	99	•
644 DS	02	•
644 R30	02	•

DUCATI

620 MULTISTRADA 620 (Bidisco)	05	•
695 MONSTER 695	06	•
803 MONSTER S2 R	05	•
803 MONSTER S2 R DARK	05	•

GAS GAS

50 WILD HP	04	• •
125 EC	97 > 99	•
200 EC	99	•
200 WILD HP	08	• •
240 WILD HP	04	• •
250 EC	97 > 99	•
250 MC	97 > 99	•
250 WILD HP	08	• •
300 EC	99	•
300 WILD HP	03	• •
450 WILD HP	03	• •
515 WILD HP	09	• •

HIGHLAND

450 MX	06	•
950 V2	99	•

HONDA

650 SLR	97	•
---------	----	---

HUSABERG

400 FC	99	•
400 FE	99	•
450 FC	03	•
450 FC (cross)	05	•
450 FE	09	•
450 FE (enduro)	05	•

450 FE E	04	•
450 FX	03	•
470 FC	01	•
470 FX	01	•
550 FC	01	•
550 FC (cross)	05	•
550 FE (enduro)	05	•
550 FE E	04	•
570 FE	09	•
600 FE, FC	99	•
650 FE (enduro)	05	•
650 FX	01	•
ALL MODELS	93	•

HUSQVARNA

125 CR	03 > 04	•
125 CR	05	•
125 CR	95 > 98	•
125 CR	99 > 02	•
125 SM	98	•
125 SMS	00 > 01	•
125 SMS	05	•
125 WR	03 > 04	•
125 WR	05	•
125 WR	95 > 97	•
125 WR	98 > 02	•
125 WR E	06	•
125 WR E	94 > 98	•
125 WR E	98 > 05	•
250 CR	01	•
250 CR	02 > 04	•
250 CR	05	•
250 CR	95 > 98	•
250 CR	99 > 00	•
250 TC	02 > 03	•
250 TE	03	•
250 TE	04	•
250 WR	01	•
250 WR	02	•
250 WR	95 > 97	•
250 WR	98 > 00	•
350 TE	95	•
360 WR	01	•
360 WR	02	•
360 WR	95 > 98	•
360 WR	98 > 00	•
400 TE	01	•
410 TE	95 > 98	•
410 TE	99 > 00	•
410 TE E	00 > 01	•
450 TC	03 > 03	•

450 TC	04	•
450 TE	03 > 03	•
450 TE	04 > 05	•
450 TE	06	•
510 TC	02 > 04	•
510 TC	05	•
510 TE	05	•
510 TE	06	•
510 TE CENTENNIAL	04	•
510 TE R	04	•
570 TC	02	•
570 TE	01 > 04	•
610 TC	96 > 97	•
610 TC	98	•
610 TC	99 > 00	•
610 TE	96 > 97	•
610 TE	98	•
610 TE	99 > 00	•
610 TE E	00 > 01	•
610 TE E	03 > 04	•
610 TE E	98	•
610 TE E	99	•
610 TE E DUAL PURPOSE	06	•
610 TE E LT	99	•

KRAMIT

250 GS, MX, SM	97	•
----------------	----	---

KTM

125 EGS	94 > 97	•
125 EGS	98	•
125 EGS	99	•
125 EGS	93	•
125 EXC	00	•
125 EXC	01 > 03	•
125 EXC	04	•
125 EXC	94 > 97	•
125 EXC	98	•
125 EXC	99	•
125 EXC	93	•
125 EXE	00 > 01	•
125 GS	92	•
125 LC2	96 > 98	•
125 MX	92	•
125 SUPERMOTO	00 > 01	•
125 SX	01 > 03	•
125 SX	04	•
125 SX	94 > 97	•
125 SX	98	•
125 SX	99 > 00	•
125 SX	92 > 93	•



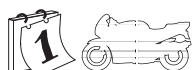

2

125	SXS	01 > 02	•	360	MXC	97	•	525	SX	03	•
144	SX	07 > 08	•	360	SX	96 > 97	•	525	SX	04	•
150	SX	09	•	380	EGS	98	•	525	SX RACING	05	•
200	EGS	98	•	380	EGS	99	•	525	XC DESERT RACING	04	•
200	EGS	99	•	380	EXC	00	•	530	EXC	08	•
200	EXC	01 > 03	•	380	EXC	01 > 02	•	530	EXC RACING	09	•
200	EXC	04	•	380	EXC	98	•	540	SXC	99	•
200	EXC	98	•	380	EXC	99	•	540	SXS	01 > 02	•
200	EXC	99 > 00	•	380	MXC	00	•	550	MXC	96	•
200	MXC	01 > 03	•	380	MXC	01	•	600	LC4	93	•
200	MXC	98	•	380	MXC	98	•	620	EGS	94 > 97	•
200	MXC	99 > 00	•	380	MXC	99	•	620	EGS ADVENTURE	97	•
200	SX	04	•	380	SX	01 > 02	•	620	EXC	94	•
250	EGS	94 > 98	•	380	SX	98	•	620	LC4	98 > 99	•
250	EGS	99	•	380	SX	99 > 00	•	620	LC4 RALLY DAKAR	97	•
250	EXC	01 > 03	•	400	EGS	94 > 97	•	620	SC	01	•
250	EXC	04	•	400	EXC	00	•	620	SUPERMOTO	01	•
250	EXC	94 > 98	•	400	EXC	01 > 02	•	620	SX	94 > 97	•
250	EXC	99 > 00	•	400	EXC	94 > 96	•	620	SX	98	•
250	EXC RACING	03 > 04	•	400	EXC RACING	05	•	620	SX	99	•
250	EXC RACING	05	•	400	LC4	98 > 01	•	620	SXC	97	•
250	EXC-F	06	•	400	MXC	02	•	625	SC	02	•
250	MX	92	•	400	SUPERMOTO	01	•	625	SUPERMOTO	02	•
250	MXC	00	•	400	SX	01 > 02	•	625	SXC	03	•
250	MXC	01	•	400	SX	98	•	640	ADVENTURE	98 > 02	•
250	SX	01 > 02	•	400	SX	99 > 00	•	640	LC4	05	•
250	SX	03	•	400	SXC	97	•	640	LC4	98 > 04	•
250	SX	94 > 98	•	440	SX	94	•	640	LC4 ADVENTURE	03 > 04	•
250	SX	99 > 00	•	450	450 XC-F	08	•	640	LC4 ENDURO	03 > 05	•
250	SX	92 > 93	•	450	EXC	03	•	640	LC4 ENDURO	06	•
250	SXC	03	•	450	EXC	04	•	640	LC4 RALLY DAKAR	97	•
250	SX-F	06	•	450	EXC RACING	05 > 06	•	640	LC4 SUPERMOTO	00 > 02	•
250	SXS	01	•	450	EXC RACING	07	•	660	LC4 RALLY	00 > 02	•
300	EGS	94 > 98	•	450	MXC	03	•	660	LC4 RALLY	99	•
300	EGS	99	•	450	SX	03 > 03	•	660	LC4 RALLY DAKAR	97	•
300	EGS	93	•	450	SX	04	•	660	RALLYE FACTORY REPLICA	03	•
300	EXC	01 > 03	•	450	SX RACING	05	•	950	ADVENTURE	03	•
300	EXC	04	•	450	SX-F	07	•	950	ADVENTURE	01 > 02	• •
300	EXC	94 > 98	•	500	MX	92	•	950	ADVENTURE S	03	•
300	EXC	99 > 00	•	500	SX	92 > 93	•	950	ADVENTURE S	03	•
300	EXC	93	•	505	505 XC-F	09	•	950	LC8 RALLYE	02	•
300	MXC	01 > 03	•	505	SX-F	07	•	950	SUPER ENDURO	07	•
300	MXC	97 > 98	•	520	EXC	00	•	950	SUPER ENDURO R	06	•
300	MXC	99 > 00	•	520	EXC	01 > 02	•	950	SUPERMOTO	05	•
300	SX	06	•	520	MXC	01 > 02	•	950	SUPERMOTO R	07	•
300	SX	92 > 93	•	520	SX	00	•	990	ADVENTURE	06	•
300	SX	94	•	520	SX	01 > 02	•	990	ADVENTURE S	06	•
350	EXC	94	•	525	EXC	03	•	990	LC8 990 SUPERMOTO	09	•
350	EXC LC4	93 > 94	•	525	EXC	04	•	990	LC8 990 SUPERMOTO R	09	•
360	EGS	96 > 97	•	525	EXC RACING	05	•	990	LC8 990 SUPERMOTO T	09	•
360	EXC	96 > 97	•	525	MXC	03	•	990	SUPERMOTO	06	•



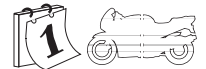
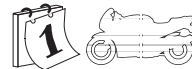
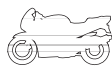
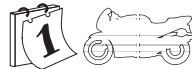
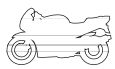

MAICO

250 CROSS, ENDURO	99	•
500 CROSS, ENDURO	99	•
500 SUPERMOTARD	99	•

MOTO GUZZI

850 BREVA 850	06	•
850 GRISO 850	06	•
940 CUSTOM 940 BELLAGIO	07	•
1100 BREVA	05	•
1100 GRISO	05	•
1100 QUOTA ES	99 > 01	•
1200 1200 SPORT 4V	09	•
1200 GRISO 8V	07	•
1200 NORGE, ABS	06	•
1200 SPORT	06	•
1200 SPORT ABS	06	•
1200 STELVIO	08	•

MOTO MORINI

1200 GRANPASSO	08	•
1200 SCRAMBLER	09	•

RIEJU

450 MRX	08	•
---------	----	---

SHERCO

250 2.5 i ENDURO	06	•
450 ENDURO	04	•

450 ENDURO	05	•
510 5.1 i ENDURO	06	•

TM

80 CROSS	96	•
85 85	01	•
125 125	01 > 04	•
125 125	96 > 00	•
125 ENDURO	01 > 04	•
250 250	01 > 04	•
250 250 4-stroke	01	•
250 E	01	•
250 E	95 > 00	•
250 E 4-stroke	00	•
250 E 4-stroke	01 > 04	•
300 300	01	•
300 300	98 > 00	•
300 E	01 > 04	•
320 320	96	•
400 4T	00	•
400 4T	01	•
400 E 4 stroke	01	•
450 4T	02 > 04	•
450 ENDURO 4 stroke	02 > 04	•
450 F	05	•
450 F ENDURO	05	•
530 4T	01 > 04	•
530 E 4 stroke	01 > 04	•
530 F	05	•

530 F ENDURO	05	•
--------------	----	---

VERTEMATI

500 CROSS	02	•
501 ENDURO	02	•
501 SUPERMOTARD	02	•

VOR

400 CROSS	00 > 01	•
400 EN	02	•
400 MX	02	•
450 EN	02	•
450 MX	02	•
500 CROSS 495)	99	•
500 ENDURO 492)	99	•
530 EN	02	•
530 MX	02	•

YAMAHA

125 YZF R	08	•
600 TT	93	•
600 TT 600	97	•
600 TT 600 R	97	•
660 XT Z Ténéré	08	•



07BB05.SA	35x 40,5x 7,5
07BB05.SC	" " "
07BB05.RC	" " "
07BB05.54	" " "
GENUINE	
07BB05.90	" " "
GENUINE	

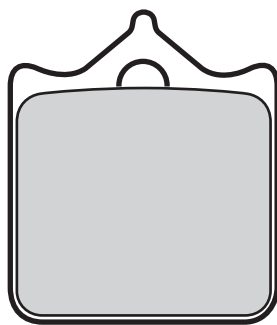

2



APRILIA

1000 RSV	02	•
1000 RSV FACTORY	04	•
1000 RSV NERA	04	•
1000 RSV R	01 > 03	•
1000 TUONO R	03	•
1000 TUONO RACING	04	•

BENELLI

449 BX Supermotard	08	•
756 CUE	07	•
900 TORNADO 3	03	•
1130 TNT CAFE' RACER	05	•
1130 TNT SPORT	05	•
1130 TNT TITATIUM	05	•
1130 TORNADO TRE	06	•

BIMOTA

1000 DB5	05	•
1000 DB5	07	•
1000 DB6 DELIRIO	06	•
1000 SB8 K SANTAMONICA	06	•
1098 DB7	08	•
1100 DB6 R DELIRIO	08	•
1100 TESI 3D	07	•

BMW

450 G 450 SMR	09	•
---------------	----	---

CAGIVA

1000 X-RAPTOR	03	•
---------------	----	---

DERBI

659 MULHACÉN	06	•
659 MULHACÉN CAFÉ	08	•

DUCATI

748 748 R	01 > 02	•
748 749	03 > 07	•
748 749 DARK	05 > 06	•
748 749 R	03 > 07	•
748 749 S	03 > 07	•
996 996 R	01	•
998 998 F.E.	04	•
998 998 R	02	•
998 998 S	02	•
998 999	03 > 07	•
998 999 R	03 > 07	•
998 999 S	03 > 07	•
998 999 XEROX	06	•
998 MONSTER S4 R Testastretta	07	•
998 MONSTER S4 RS Testastretta	06	•

HUSQVARNA

250 SMR	06	•
450 SMR	05	•
450 SMR	06	•
450 SMR R	06	•
510 SM CENTENNIAL	06	•
510 SMR	05	•
510 SMR	06	•
570 SMR	03 > 04	•
610 SM	05	•

610 SMS	06	•
---------	----	---

HYOSUNG

450 RX SM	08	•
-----------	----	---

KTM

690 DUKE	08	•
690 SMC	08	•
690 SUPERMOTO PRESTIGE	07	•
950 DUKE	03	•
950 SUPERMOTO	05	•
950 SUPERMOTO R	07	•
990 LC8 990 SUPER DUKE R	09	•
990 LC8 990 SUPERMOTO	09	•
990 LC8 990 SUPERMOTO T	09	•
990 SUPER DUKE	05	•
990 SUPER DUKE	06	•
990 SUPER DUKE R	07	•
990 SUPERMOTO	06	•

LAVERDA

1000 SFC 1000 (Limited Edition)	03	•
---------------------------------	----	---

MONDIAL

1000 PIEGA	02	•
1000 PIEGA EVO	04	•
1000 PIEGA RZ NUDA	04	•
1000 STARFIGHTER RZ	04	•

MOTO GUZZI

750 GRISO	04	•
-----------	----	---



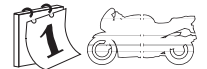
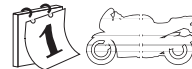
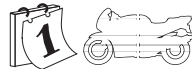
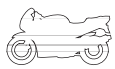

1200 MGS-01 CORSA 05 •

MV AGUSTA

910 BRUTALE R 06 •
 1000 F4 R 312 07 •
 1000 F4 R, R 1+1 06 •
 1000 F4 SENNA 06 •

SHERCO

450 4.5 i SUPERMOTARD 06 •

TM

660 SMX F 05 •

TRIUMPH

1050 SPEED TRIPLE 08 •
 1050 SPEED TRIPLE 09 •
 1050 SPEED TRIPLE (SPECIAL EDITION) 09 •

2



07BB06.06 119,7x51,8x7,8

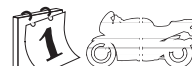
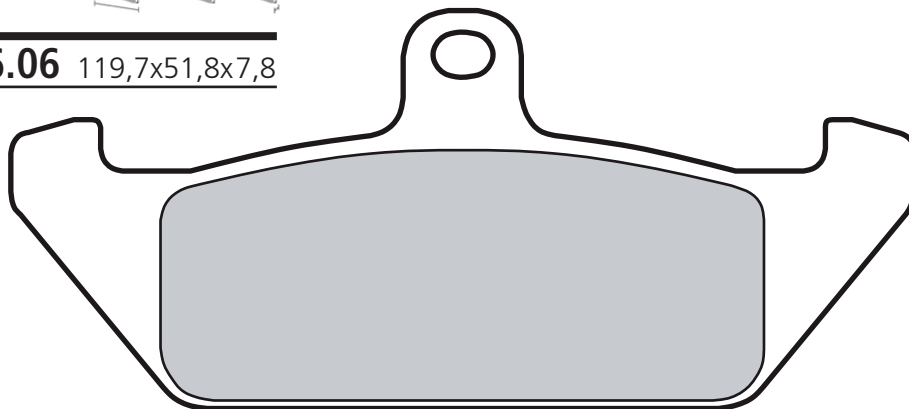

APRILIA

600 TUAREG WIND 88 > 89 •

CAGIVA

350 ELEFANT 85 •
 650 ELEFANT 85 > 87 •
 750 ELEFANT 87 •
 750 ELEFANT 88 > 90 •
 750 LUCKY EXPLORER 88 •

DUCATI

650 INDIANA 86 •
 750 INDIANA 89 •

LAVERDA

600 ATLAS 86 •

MOTO GUZZI

650 VT 65 TT BAJA 86 •

750 NTX 89 •

MOTO MORINI

350 INDIANA 88 •
 501 EXCALIBUR 86 • •
 501 EXCALIBUR 89 > 89 •
 650 INDIANA 88 •
 750 INDIANA 88 •





07BB07.TT 84,9x42,4x 7,5
55,8x 37x 9,8

07BB07.08 " " "

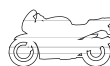
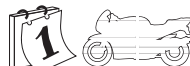
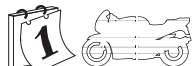
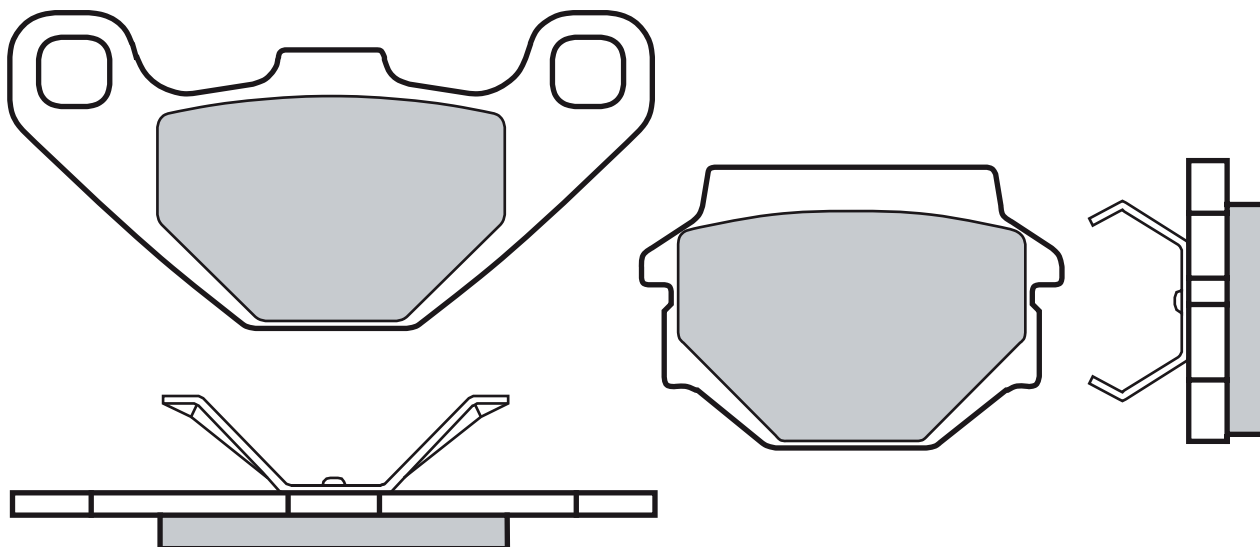

APRILIA

125 MX Supermoto	07	•
125 PEGASO	90 > 91	•
125 RX	91	•
125 RX	96	•
125 TUAREG WIND	90	•
350 TUAREG	88	•
350 TUAREG WIND	90	•
600 TUAREG	88	•
600 TUAREG WIND	90	• •
650 MOTO	95	•
650 PEGASO	92 > 95	•
650 PEGASO	96	•
650 PEGASO	97 > 03	•

CAGIVA

125 CROSS	88	•
125 W9	96	•
125 WMX	89	•
250 WMX	89	•
500 W16	94 > 98	•
600 W16	94	•

FANTIC MOTOR

50 RAIDER	84	•
-----------	----	---

50 STRADA	83	•
125 STRADA	83	•

HUSQVARNA

125 CR	91	•
125 WR	91	•
240 WR	91	•
250 CR, WR	91	•
260 WR	91	•
360 TE	95 > 98	•
510 CROSS COUNTRY LC	87	•
510 ENDURO LC	87	•
510 MOTOCROSS LC	87	•
510 TC MOTOCROSS	88	•
610 TC CROSS	91	•
610 TE	91 > 95	•

KRAMIT

50 SCRAMBLER		•
125 ER	89	•
250 ER, MC	89	•
300 ER	89	•

KTM

125 EGS	93	•
---------	----	---

125 EXC	93	•
125 GS	92	•
125 MX	89 > 91	• •
125 MX	92	•
125 SX	92 > 93	•
250 MX	89 > 91	• •
250 MX	92	•
250 SX	92 > 93	•
300 EGS	93	•
300 EXC	93	•
300 SX	92 > 93	•
350 EXC LC4	93 > 94	•
500 MX	89 > 91	• •
500 MX	92	•
500 SX	92 > 93	•
600 LC4	93	•
600 MX	91	• •

TM

400 CROSS	00	•
-----------	----	---

YAMAHA

125 TDR ITALIA	90	•
----------------	----	---





07BB09.07 99,9x46,8x 8,5

2

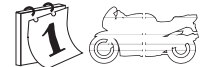
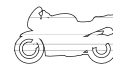
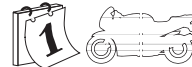
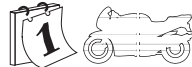
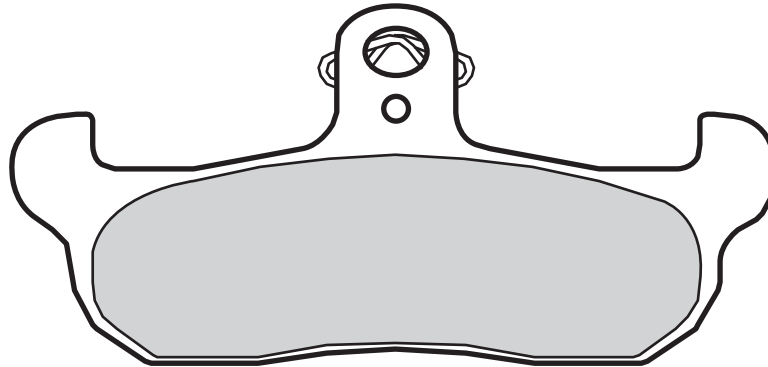

APRILIA

125 AF1	86	•
125 RX	90	•
125 TUAREG RALLY	89	•
125 TUAREG WIND	88	•
350 RALLY	86	•

CAGIVA

50 WMX	89	•
125 CROSS	88	•
125 CRUISER	87	•
125 LUCKY EXPLORER	88	•
125 WMX	87 > 88	•
125 WMX	89	•
250 WMX	87 > 88	•
250 WMX	89	•

FRIGERIO PUCH

125 F7	89	•
250 REPLAY	89	•

GILERA

125 RC TOP RALLY	89	•
600 RC	88	•

HM

50 CRE	98	•
--------	----	---

HONDA

50 CRE	93	•
--------	----	---

HUSABERG

350 350	91	•
500 500	91	•
501 ENDURO		•
600 ENDURO		•
ALL MODELS	89 > 92	•

HUSQVARNA

125 CR	91	•
125 WR	91	•
240 WR	87 > 90	•
240 WR	91	•
250 CR, WR	91	•
250 WR	87	•
250 XC	87	•
260 WR	91	•
360 TE	95 > 98	•
400 WR	87	•
430 CR	87	•
430 WR	87	•
430 XC	87	•
500 XC	87	•
510 CROSS COUNTRY LC	87	•
510 ENDURO LC	87	•

510 MOTOCROSS LC	87	•
510 TC MOTOCROSS	88	•
510 TE ENDURO	88	•
510 TX CROSS COUNTRY	88	•
610 TC CROSS	91	•
610 TE	91 > 95	•

KRAMIT

125 ER	89	•
250 ER, MC	89	•
300 ER	89	•

MOTO MORINI

400 DART	89 > 89	•
----------	---------	---

TM

80 GS	87	•
80 MC	87	•
125 GS	87	•
400 CROSS	00	•

YAMAHA

125 DT TENERE	89	•
125 TDR ITALIA	90	•





07BB12.TT 35,7 x45,4 x6
07BB12.05 " " "

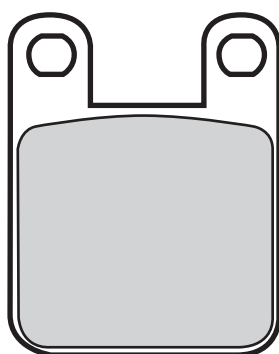

2



ALFER

80 MC 87 •

APRILIA

50 RX 08 •

240 TX 86 •

250 AF1 REPLICA 90 •

280 280 R, CLIMBER 92 • •

311 TX 86 • •

312 TX, TXR 88 > 89 •

BETA

50 REV 00 • •

50 RR ENDURO 99 •

50 RR STANDARD 99 •

50 RR SUPERMOTARD 04 > 07 • •

50 RR SUPERMOTARD 99 > 03 •

50 ST 97 • •

50 SUPER TRIAL 92 •

50 TECHNO 96 • •

50 TEMPO 92 > 96 •

80 REV 06 • •

125 ALP 99 • •

125 TR 97 •

125 TR34, TR35 88 > 90 • •

125 TRIAL 97 •

200 ALP 00 • •

240 ALP 92 > 95 •

240 ALP 96 •

240 SUPER TRIAL 92 •

250 ALP 92 > 96 •

250 ALP 97 • •

250 EIKON 99 • •

250 TECHNO 96 • •

250 ZERO 91 •

260 ALP 96 •

260 TR34, TR35 89 > 92 •

260 ZERO 91 •

BULTACO

50 ASTRO 01 •

50 LOBITO 99 •

CAGIVA

50 CORSA 98 •

50 MITO 99 •

DERBI

50 BLACK DEVIL 04 •

50 DRD PRO R 06 •

50 DRD RACING R 05 •

50 DRD RACING R L.E. 05 •

50 DRD RACING SM 05 •

50 DRD RACING SM L.E. 05 •

50 FDX 89 •

50 FENIX 94 • •

50 GP 01 •

50 GPR 98 •

50 GPR NUDE 04 •

50 GPR RACING 04 •

50 GPX1 06 •

50 SAVANNAH 91 •

50 SENDA R 03 > 04 •

50 SENDA R 94 > 99 • •

50 SENDA SM 99 > 02 • •

50 SENDA SM DRD 03 > 04 • •

50 SENDA SM DRD BLACK ED. 03 •

50 X-RACE R 05 • •

50 X-TREME R 05 • •

75 GPR 89 •

80 GPR CUP 04 •

125 BOULEVARD 09 •

125 GP1 05 •

125 GPR 05 •

125 GPR NUDE 05 •

125 GPR RACING 09 •

125 SENDA 4-stroke 04 •

125 SENDA R 4-stroke 05 •

125 SENDA X-TREME SM 04 •

125 Terra 07 • •

FANTIC MOTOR

50 CLUBMANN 94 •

50 TRIAL 89 •

250 K-ROO 91 •

250 TRIAL 91 •

305 TRIAL 88 •

307 TRIAL 91 • •

GARELLI

323 TRIAL 86 •

CICLONE LC, SM 86 •

GAS GAS

50 TXT BOY 04 • •

125 DELTA 91 •

125 PAMPERA 96 > 03 • •

200 PAMPERA 99 • •

200 TX 97 • •

250 PAMPERA 96 > 99 • •

250 TRIAL 89 • •

270 TX 97 • •





320 TX	97	• •
370 PAMPERA	96	• •

GILERA

50 HAK	99	• •
50 RCR	04	• •
50 SMT	04	• •
50 SUPERMOTARD	01	• •
50 ZULU	01	• •
125 GSM	00	• •
125 SC	06	•

HRD

50 SONIC	00 > 02	•
50 SONIC TRIAL	00 > 02	•
125 SUPERMOTARD	00	•
125 TRIAL	00	•

HUSQVARNA

50 HUSKY BOY	01	•
50 RACING	98	•
50 SM	02	•
50 WR	02	• •
50 WRS	98	•

KTM

50 SX	99	•
65 SX	00 > 01	•

MACAL

50 TROPHY	99	•
-----------	----	---

MALAGUTI

50 DRAGON	05	•
50 NKD	04	•
50 NKD DRAGON	06	•
50 XSM	03	•

MONTESA

125 COTA	88	• •
260 EVASION	92	•
304 COTA	88	• •
307 COTA	89	• •
307 COTA TRIAL	88	• •
309 COTA	89	•
310 COTA	89	•
311 COTA TRIAL	92	•
315 COTA R	97	• •
335 COTA	87 > 91	• •
360 ENDURO	85	•

MORBIDELLI MBA

125 JR	76	• •
--------	----	-----

PEUGEOT

50 BUXY R (AJP caliper)	93 > 97	•
50 JET C-TECH	05 > 08	•
50 JET C-TECH	09	• •
50 LOOXOR	02 > 05	•
50 XP6 ENDURO	06	• •
50 XP6 SUPERMOTARD	06	• •
50 XP6 TRIAL	04 > 05	• •
50 XPS6 ENDURO	02	• •
50 XPS6 SUPERMOTARD	04 > 05	•
50 XR6	02 > 07	•
50 XR7	08	•
150 LOOXOR	02	•

PUCH

50 TZX	92	•
75 COBRA	85	•

RIEJU

50 DRAC	97	• •
50 EVOLUTION RS1	96 > 00	• •
50 FD4 SUPER MARATHON	85	•
50 MATRIX	03	•
50 MRX	02 > 04	• •
50 MRX PRO	05	•
50 MX (AJP caliper)	02	• •
50 NKD	04	•
50 RACING	01	•
50 RR SUPERMOTARD	96	• •
50 RRX	08	• •
50 RRX SPIKE	08	• •
50 RS1	01	•
50 RS1	92	• •
50 RS1 CASTROL	01	•
50 RS2 MATRIX	03	•
50 SMX	02	•
50 SMX PRO	08	•
50 SPIKE	02	•
50 SPIKE (AJP caliper)	02	•
50 TANGO	08	•
80 CROSS, ENDURO	87	• •
80 RST	91	• •
125 MRX	03	•
125 MRX (AJP caliper)	03	• •
125 RR	97	• •
125 SMX	03	•
125 SMX (AJP caliper)	03	• •
125 TANGO	06 > 07	•

125 TANGO	08	•
125 TANGO PRO	08	•
250 TANGO	08	•

SCORPA

115 TY-S F TRIAL	06	•
------------------	----	---

SHERCO

50 ENDURO	07	•
50 SM, ENDURO	02	•
50 SUPERMOTARD	07	•
80 80	01	• •
125 125	01	• •
125 125	02	•
125 CITY CORP 4T ENDURO	03	•
125 CITY CORP 4T SM	03	•
200 200	01	• •
250 250	99 > 00	• •

SIMSON

125 SM	01	•
125 STAR	99	•

SUZUKI

50 DR BIG	89	•
50 RMX	00	• •
50 SMX SUPERMOTARD	00	• •

TGB

50 CAPPUCCIO	09	•
--------------	----	---

YAMAHA

50 DT R	04	•
50 TZR	03	•
125 XT R	05	• •
125 XT X SUPERMOTARD	05	•
250 TY R	91 > 92	•
250 TY Z	93	• •



2



07BB13.SD	35,8x51,6x5,90
07BB13.05	" " "
07BB13.24	" " "
GENUINE	

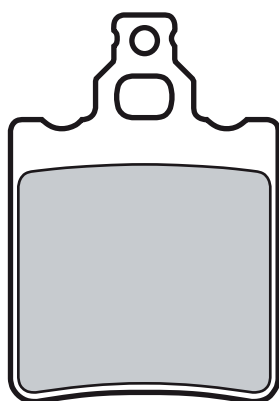

APRILIA

50 AF-1	86	•
50 AF-1 FUTURA, EUROPA	90	•
50 ET	85	•
50 ET TUAREG	86	•
50 MX	03	•
50 PEGASO	0	•
50 REPLICA	92	•
50 RS	93 > 95	•
50 RS	96 > 99	•
50 RS REPLICA	03 > 05	•
50 RS, RS REPLICA	00	•
50 RX	90 > 91	•
50 RX	92	•
50 RX RACING	04 > 07	•
50 TUAREG	85	•
50 TUAREG	86	•
50 TUAREG RALLY	90	•
125 TUAREG WIND	88	•
240 CLIMBER	89 > 90	•
275 275 CLIMBER	89 > 90	•

BENELLI

125 BXK	88	•
---------	----	---

BETA

350 4.0 MOTARD	04	•
350 ALP 4.0	04 > 05	•

CAGIVA

50 BLUES	89	•
50 LUCKY EXPLORER	88	•
50 W4	92	•

80 COCIS	91	•
80 W4	92	•
125 ALETTA ORO	85 > 86	• •
125 ALETTA ORO	87	• •
125 ALETTA ROSSA	83	•
125 CRUISER	87	•
125 DAKAR	89 > 90	•
125 E2	86	•
125 ELECTRA	87	•
125 ELECTRA,ELEFANT	83 > 86	•
125 LUCKY EXPLORER	88	•
125 N 90	90	•
125 SPORT	85	• •
125 SXT, SST	81	•
125 TAMANACO	89	•
125 W8	92 > 98	•
200 ALETTA ELECTRA	83	•
200 CROSS	83	•

FANTIC MOTOR

50 CABALLERO RS / RC	90	•
50 KOALA	88 > 95	• •
50 K-ROO	91	•
50 OASIS	88 > 89	• •
50 OASIS	90	•
50 RC CABALLERO RS	91	•
75 OASIS	89	•
125 K-ROO	91	•
125 RAIDER LC	83 > 84	•
250 K-ROO	91	•
250 TRIAL	91	•
305 TRIAL	88	•

FRIGERIO PUCH

125 CROSS	84 > 85	•
125 REPLAY	89	•

GARELLI

125 STRADA GTA	83 > 85	• •
125 STRADA, SPORT	84 > 85	•
125 TIGER XLE	86	•

GILERA

125 X1	89 > 89	•
250 NGR	85	•

HRD

125 SILVER HORSE	85	• •
------------------	----	-----

LAVERDA

125 125	84	•
125 CUSTOM	86	• •
125 GS LESMO	86	• •
125 LB (CU/SP)	84	•
125 LB SPORT	84	•
125 LB STRADA	85	•
125 LESMO	86	• •
125 LS STRADA	85	•
125 NAVARRO	90	• •
125 TOLEDO	90	• •
150 FORMULA	86	•

MALAGUTI

50 DUNE ES	89	• •
50 EVOLUTION	91	•
50 MDX	86	•



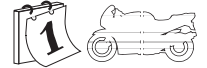
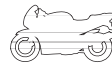
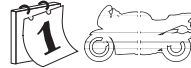
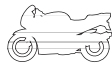
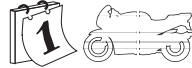

50	RST SPORT	88	• •
50	XTM	03	• •

MALANCA

80	GTI	0	• •
----	-----	---	-----

125	GTI	80	• •
125	MARK ENDURO	85	•
125	OB ONE M6	85	• •
125	SPORT	78	• •

ZUNDAPP

80	KS SUPER	80	•
80	KS SUPER	82	•

2





07BB14.SP 55,6x 53,8x 8,9
07BB14.08 " " "
07BB14.18 " " "
 G E N U I N E

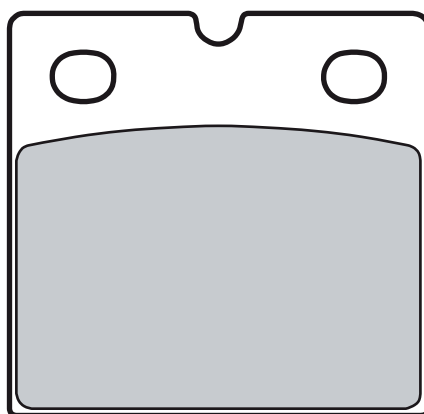

2



BENELLI

350	354 TURISMO, SPORT	83	•
500	504 SPORT	76	•
650	654	83	•
650	654 SPORT	83	•
750	SEI	75	•
900	SEI	78	•

BIMOTA

1000	DB 1	87	•
1200	YB 5 FS	87	•
	HB 2	80	• •
	HB 3	82	• •
	KB 1/A	78	• •
	KB 2	81	• •
	KB 2/S	81	• •
	KB 3	82	• •
	SB 3	80	• •
	SB 4	82	• •

BMW

450	R 45	81	•
650	R 65	81	•
650	R 65 LS	82	•
750	K 75 RT	91	•
750	K 75, K 75C, K 75T	84	•
750	K 75S	83	• •
800	R 80	81	•
800	R 80 GS	81 > 87	•
800	R 80/7	79 > 81	•
1000	K 1	89	•
1000	K 100	83	• •
1000	K 100 ABS (special caliper)	91	•

1000	K 100 LT	87 > 91	• •
1000	K 100 LT	92	•
1000	K 100 RS	83	• •
1000	K 100 RS 16V.	90	•
1000	K 100 RT	84	• •
1000	R 100 CS	81 > 83	•
1000	R 100 CS	84	• •
1000	R 100 R	91	•
1000	R 100 RS	76 > 80	•
1000	R 100 RS	81 > 83	•
1000	R 100 RS	84	• •
1000	R 100 RT	79 > 80	•
1000	R 100 RT	81 > 83	•
1000	R 100 RT	84	• •
1000	R 100 S	78 > 80	•
1000	R 100 T	79	•
1100	K 1100 LT	92	•
1100	K 1100 RS	93	•
1100	R 1100 RS	93	•
1200	K 1200 GT ABS	02 > 08	•
1200	K 1200 RS	01	•
1200	K 1200 RS	97 > 00	•

CAGIVA

500	RIVER	99	•
-----	-------	----	---

DUCATI

600	PANTAH	81	•
650	SL	84	•
750	LAGUNA SECA	87	•
750	PASO	87 > 88	•
750	SANTAMONICA	87	• •
750	SPORT	74 > 76	•

750	SPORT	88	• •
900	MIKE HAILWOOD Replica	85	• •
900	REPLICA	85	• •
900	S2	82	• •
900	S2 DESMO	85	• •
900	SUPERSPORT 900	81	• •
906	PASO	89	• •
906	SANTAMONICA	87	• •
1000	MIKE HAILWOOD Replica	85	• •
1000	R1	84	• •
1000	S2 DESMO	85	• •

HOREX

125	IMPERATOR	96	•
125	REGENT	96	•
560	560 E	86	•
600	COLUMBUS	87	•

HRD

600	600 (HOREX)	85	• •
-----	-------------	----	-----

LAVERDA

650	SFC	86	• •
650	V-SIX	93	• •
750	SF3	74 > 78	•
1000	1000	73	•
1000	EXECUTIVE	84	• •
1000	JOTA	84	• •
1000	RGS 1000	82 > 83	• •
1000	SFC	86	• •

MOTO GUZZI

750	NTX	90	•
-----	-----	----	---



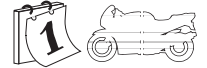
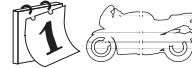
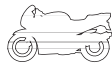
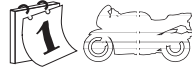

750 S3	75 > 76	•
750 SP	91	• •
750 V75	86	• •
850 850 LE MANS	76 > 80	•
850 850 LE MANS III	81 > 84	• •
850 850 LE MANS T4 (Germany)	85	• •
850 850 T3	75	• •
850 850 T3 CALIFORNIA	76	•
850 850 T3 CARABINIERI, POLIZIA	83	• •
850 850 T3 GERMANIA	75	•
850 850 T4	83	• •
850 850 T5	85 > 88	• •
1000 CALIFORNIA II	83 > 86	•
1000 CALIFORNIA III	87 > 93	• •
1000 GS CONVERT	75	• •
1000 GS CONVERT GERMANIA	75	•
1000 GT 1000	87 > 91	• •
1000 LE MANS IV	85 > 89	• •
1000 S 1000	89 > 94	• •
1000 SP 1000	78	•
1000 SP 1000 II	83 > 88	• •
1000 SP 1000 III	89 > 94	• •
1000 STRADA	93 > 94	• •

1000 V	93	•
1000 V CALIFORNIA		• •
1000 V I CONVERT		•
1100 CALIFORNIA	94 > 97	• •
1100 SPORT	01	•

MZ

125 ETZ	82	•
125 ROADSTER		•
125 SPORTSTAR	93	•
150 ETZ	82	•
250 ETZ	82	•
251 ETZ	81	•
251 SAXON TOUR	96	•
251 SPORTSTAR MUZ	96	•
300 ETZ LUX	90	•
300 ETZ X	88	•
301 ETZ	90	•
301 SAXON TOUR		•
301 SPORTSTAR MUZ	96	•
500 SAXON COUNTRY	92	•
500 SAXON FUN	92	•
500 SAXON VOYAGER		•

500 SILVER STAR CLASSIC	93	•
-------------------------	----	---

NORTON

COMMANDER	90	• •
F 1	90	•
INTERPOL	83	• •
WANKEL CLASSIC	88	• •

OSSA

500 YANQEE	78	•
------------	----	---

SWM

350 SAHARA		•
------------	--	---

TRIUMPH

750 BONNEVILLE	87	• •
----------------	----	-----

ZUNDAPP

175 KS	81	•
--------	----	---



07BB15.SA	69,7x	51x	8,4
07BB15.SC	"	"	"
07BB15.RC	"	"	"
07BB15.07	"	"	"
07BB15.35	"	"	"
GENUINE			

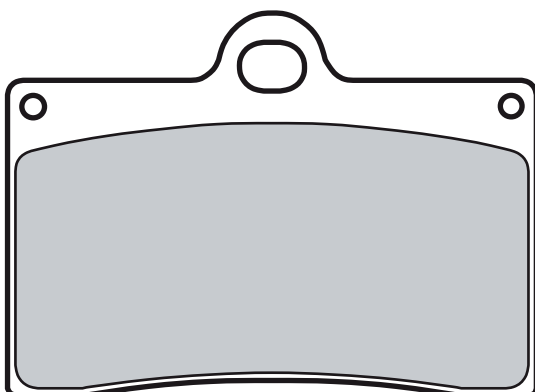

2



APRILIA

250 AF1 REPLICA	90	•
250 RS	95 > 97	•

BETA

125 JONATHAN	99	•
350 4.0 MOTARD	04	•
350 EURO	99	•
350 JONATHAN	02	•
350 M4	06	•
350 M4 (EBE)	06	•

BIMOTA

400 YB 7	94	•
500 V due	97	•
600 BELLARIA	90 > 92	•
600 BELLARIA	93	•
600 YB 9 SR, SRI	97	•
650 SUPERMONO BIPOSTO	97	•
750 SB7	94	•
750 YB 4	88	•
851 TESI	91	•
900 DB2	93	•
900 DB2 SR	94	•
900 MANTRA	97	•
906 TESI	91	•
1000 DB 1	91	•
1000 DB 1 RS	87	•
1000 FURANO	92	•
1000 TESI 2D	04 > 06	•
1000 TUATARA	90	•
1000 YB 11	97	•
1000 YB 6	87	•

1000 YB 8	89	•
1100 SB6	94	•
1100 SB6	97	•

CAGIVA

125 MITO 2	92 > 93	•
125 MITO 525	08	•
125 MITO EURO2	04	•
125 MITO EV	94 > 03	•
125 N1	96	•
125 PLANET	98 > 00	•
125 RAPTOR	03	•
600 RIVER	94	•

DUCATI

350 SUPERSPORT 350	92	•
400 MONSTER 400	95 > 97	•
400 SUPERSPORT 400	93 > 97	•
500 502 SINGLE	93	•
500 502 SUPERMONO	93	•
600 MONSTER 600	93 > 97	•
600 MONSTER 600 CITY, DARK CITY	99	•
600 MONSTER 600, DARK	98	•
600 SUPERSPORT 600	91 > 97	•
748 748 BIPOSTO	95 > 97	•
748 748 BIPOSTO	98	•
748 748 SP	95 > 97	•
750 F1	86	•
750 LAGUNA SECA	87	•
750 MONSTER 750 (bidisco)	96 > 98	•
750 MONSTER 750 (monodisco)	96 > 97	•
750 MONSTER 750 CITY, DARK CITY	99	•
750 SUPERSPORT 750	91 > 98	•

851 851	89	•
851 851 SP2	90	•
851 851 SP3 / 851 SUPERBIKE	91	•
888 888 RACING	92	•
888 888 SP4	92	•
888 888 SP5	93	•
888 888 SUPERBIKE STRADA	94 > 95	•
888 SPORT PRODUCTION	92	•
900 FE	97	•
900 MONSTER 900	93 > 99	•
900 MONSTER 900 CITY, DARK CITY	99	•
900 MONSTER 900 CROMO	98	•
900 MONSTER 900 SPECIAL	98	•
900 SUPERLIGHT 900	92 > 97	•
900 SUPERSPORT 900	90 > 97	•
907 I.e.	92	•
916 916	94 > 96	•
916 916 BIPOSTO, SENNA	94 > 98	•
916 916 S, 916 SP	94 > 96	•
916 916 SPS	97	•

GAS GAS

125 SM	02	•
250 SM	02	•
400 FSE SM	02	•
450 FSE SM	03 > 06	•
450 SM FSR	07	•

GILERA

350 SATURNO	88	•
500 SATURNO	88	• •
600 SATURNO PIUMA	90	•



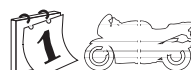

HONDA

125 RS (GP)	95	•
250 RS R	93	•

HUSQVARNA

400 SM R	02	•
450 SMR	03 > 04	•
570 R	01	•
570 SMR	01	•
570 SMR	02	•
570 SMR R	04	•

ITALJET

900 GRIFON	00	•
------------	----	---

KTM

125 STING	99	•
400 DUKE	94 > 95	•
450 SM FACTORY REPLICA	04	•
450 SMR	04	•
525 SMR	04	•
620 DUKE	94 > 97	•
640 DUKE	98	•
640 LC4 SUPERMOTO	03 > 04	•
660 SM FACTORY	02	•
660 SM FACTORY REPLICA	03	•
660 SMC	03	•
660 SMS	07	•

LAVERDA

650 FORMULA	94 > 95	•
650 GHOST	96	•
650 SPORT	94 > 95	•
650 STRADA	96	•
668 668	96	•
668 DIAMANTE	96 > 98	•
668 GHOST STRIKE LEGEND	96 > 98	•

750 750 S SPORT	99 > 00	•
-----------------	---------	---

750 CUP	98	•
---------	----	---

750 DIAMANTE	97	•
--------------	----	---

750 GHOST STRIKE	97	•
------------------	----	---

750 S FORMULA	99 > 00	•
---------------	---------	---

750 S, S SCARENATO	97 > 98	•
--------------------	---------	---

750 STRIKE BIFARO	98 > 99	•
-------------------	---------	---

750 STRIKE MONOFARO	98 > 99	•
---------------------	---------	---

750 T8	98	•
--------	----	---

800 TTS	99	•
---------	----	---

MOTO GUZZI

1000 DAYTONA	92 > 95	•
--------------	---------	---

1000 DAYTONA RACING	92 > 96	•
---------------------	---------	---

1000 DAYTONA RS	97 > 98	•
-----------------	---------	---

1000 V10 CENTAURO	97 > 99	•
-------------------	---------	---

1100 CALIFORNIA EV	97 > 00	•
--------------------	---------	---

1100 CALIFORNIA JACKAL BASIC	00	•
------------------------------	----	---

1100 CALIFORNIA SPECIAL	99 > 00	•
-------------------------	---------	---

1100 SPORT	94 > 96	•
------------	---------	---

1100 SPORT CORSA	98 > 99	•
------------------	---------	---

1100 SPORT INIEZIONE	96 > 99	•
----------------------	---------	---

MZ

660 SKORPION CUP MUZ	99	•
----------------------	----	---

660 SKORPION REPLICA MUZ	97	•
--------------------------	----	---

NORTON

F 1	90	•
-----	----	---

TT	92	•
----	----	---

PGO

250 G-MAX	06	•
-----------	----	---

SACHS

125 X-ROAD 4T	05	•
---------------	----	---

125 XTC	99	•
---------	----	---

125 XTC N	99	•
-----------	----	---

650 ROADSTER	01	•
--------------	----	---

800 B 805	02	•
-----------	----	---

800 ROADSTER	00	•
--------------	----	---

800 S 805	03	•
-----------	----	---

TM

125 SMR	05	•
---------	----	---

125 SMX	06	•
---------	----	---

400 SMR F	02	•
-----------	----	---

400 SMR F	03	•
-----------	----	---

450 SMR F	04	•
-----------	----	---

450 SMX F	03	•
-----------	----	---

530 SMR F	03	•
-----------	----	---

530 SMR F ES	03	•
--------------	----	---

600 SMX F	03	•
-----------	----	---

VOR

400 SM	02	•
--------	----	---

450 SM	02	•
--------	----	---

500 SUPERMOTARD (492)	00 > 01	•
-----------------------	---------	---

530 SM	02	•
--------	----	---

VOXAN

1000 CAFE RACER	01	•
-----------------	----	---

1000 ROADSTER	01	•
---------------	----	---

YAMAHA

125 TZR R ITALIA	92	•
------------------	----	---

250 TZR R	94	•
-----------	----	---

660 SZR	96	•
---------	----	---



07BB16.06 100,1x51,7x7,6

2

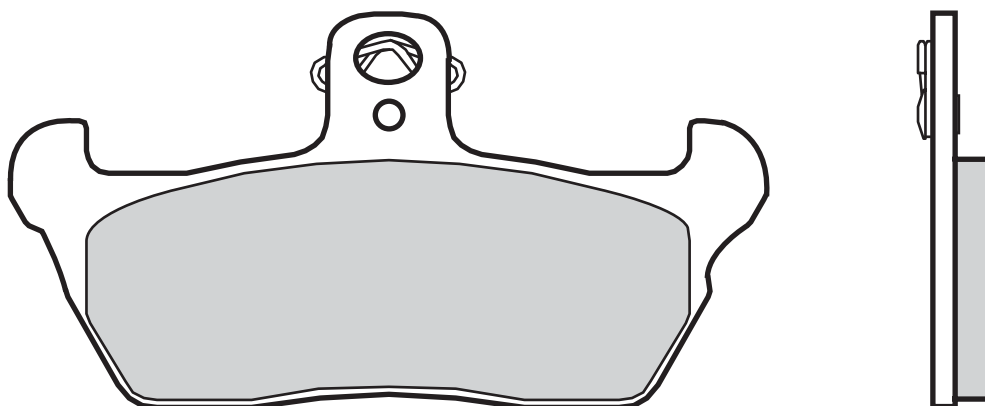

APRILIA

125 RX	91	•
125 TUAREG RALLY	90 > 91	•
350 TUAREG	88	•
350 TUAREG WIND	90	•
600 TUAREG	88	•

CAGIVA

80 SUPER CITY	94	•
125 K 7	90	•
125 MITO	90	•
125 N 90	90	•
125 SUPER CITY	92	•
125 TAMANACO	89	•
125 W9	96	•

350 W12	92	•
500 W16	94 > 98	•
600 W16	94	•
750 ELEFANT	88 > 90	•

GILERA

125 APACHE	91 > 93	•
600 R, RC	91	•

MOTO GUZZI

1000 QUOTA	92 > 95	•
------------	---------	---

MOTO MORINI

350 COGUARO, NEW YORK	89	•
350 DART	87	•

350 DART	88 > 89	•
350 EXCALIBUR	87	•
350 KANGURO	87	•
400 DART	90	•
501 COGUARO	89	•
501 EXCALIBUR	90	•
501 KANGURO	87	•
501 NEW YORK	89	•

SUZUKI

250 WOLF	90	•
----------	----	---

YAMAHA

125 TDR R ITALIA	92	•
------------------	----	---





07BB18.34 39,8x 49,5x 7
 GENUINE

07BB18.40 " " "
 GENUINE

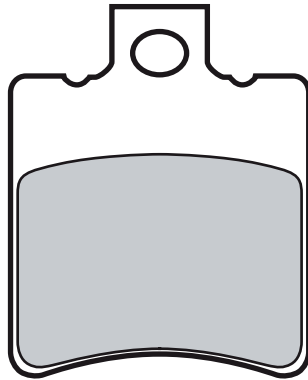

2

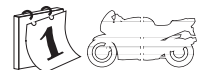
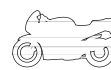
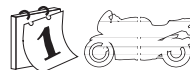
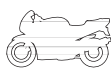
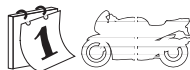

APRILIA

125	RX	85	•
250	RS	95 > 97	•
250	RS	98 > 01	•

BIMOTA

1000	SB8 K GOBERT	04	•
1000	TESI 2D	04 > 06	•

FANTIC MOTOR

50	RC CABALLERO RS	91	•
----	-----------------	----	---

GARELLI

125	TIGER XR, XRD	83	•
-----	---------------	----	---





2



07BB19.SA	75,1x 55,5x 8,7
07BB19.SC	" " "
07BB19.RC	" " "
07BB19.07	" " "
07BB19.35	" " "
GENUINE	
07BB19.54	" " "
GENUINE	
07BB19.59	" " "
GENUINE	
07BB19.73	" " "
GENUINE	
07BB19.90	" " "
GENUINE	

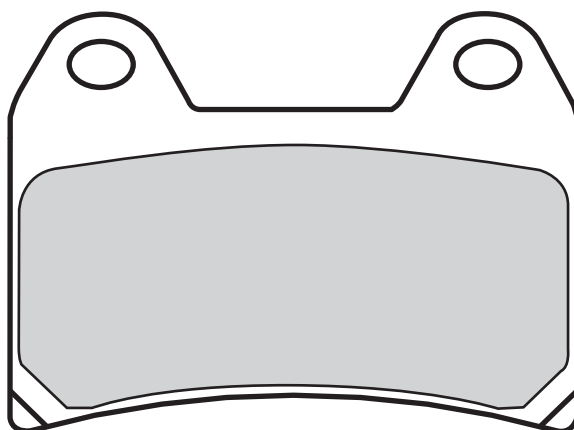

APRILIA

250 RS	98 > 01	•
650 PEGASO STRADA	05	•
750 SMV DORSODURO	08	•
750 SMV DORSODURO	08 > 08	•
1000 BLU MARTIN	02	•
1000 RST FUTURA	01 > 04	•
1000 RSV	97 > 01	•
1000 RSV R	00	•
1000 RSV SL FALCO	00 > 04	•
1000 RSV SP	99	•
1000 TUONO FIGHTER	03	•

BENELLI

125 BORN IN HELL	98	•
899 TNT	07	•
899 TRE 899 K	09	•
900 TORNADO 3	00 > 02	•
1100 TNT	04	•
1130 TNT	05	•
1130 TRE-K	06	•

BIMOTA

900 DB4	99	•
1000 SB8 K GOBERT	04	•

1000 SB8 K SANTAMONICA	07	•
1000 SB8 R	98	•

BMW

650 G 650 Xmoto	07	•
800 F 800 S	06	•
800 F 800 S, R	09	•
800 F 800 ST	06	•

CAGIVA

125 RAPTOR	05	•
650 RAPTOR	01 > 05	•
650 V-RAPTOR	01 > 05	•
1000 RAPTOR	00	•
1000 V-RAPTOR	00	•
1000 X3 RAPTOR	04	•
1000 XTRA RAPTOR	02	•

DUCATI

400 MONSTER 400	03 > 04	•
400 MONSTER 400 (Monodisco)	05	•
400 MONSTER 400 DARK	03	•
600 MONSTER 600 METALLIC	00 > 01	•
600 MONSTER 600, DARK, DARK CITY	00	•
620 MONSTER 620 (Bidisco)	05	•

620 MONSTER 620 DARK (Monodisco)	04	•
620 MONSTER 620 DARK (Monodisco)	05	•
620 MONSTER 620 i.e. DARK	02	•
620 MONSTER 620 i.e./620 S i.e.	02	•
620 MONSTER 620 i.e./620 S i.e./DARK	03	•
620 MONSTER 620, DARK	04	•
620 MULTISTRADA 620 DARK (Monodisco)	05	•
620 MULTISTRADA 620 DS	03	•
620 SUPERSPORT 620 S	03	•
696 MONSTER 696	08	•
696 MONSTER 696	08	•
696 MONSTER 696 / 696 +	09	•
748 748	00 > 02	•
748 748 BIPOSTO	99	•
748 748 R	00	•
748 748 S	00 > 02	•
748 748 SPS	98 > 99	•
750 MONSTER 750 DARK i.e.	02	•
750 MONSTER 750, METALLIC, DARK	00 > 01	•
750 SPORT	00	•
750 SUPERSPORT 750	99	•
750 SUPERSPORT 750 i.e.	00 > 02	•
750 SUPERSPORT 750 S i.e.	02	•
803 MONSTER 800	04	•
803 MONSTER 800 S i.e.	03	•



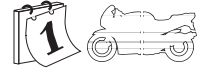
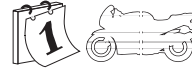
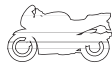
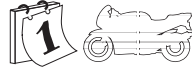

803	SUPERSPORT 800	06	•
803	SUPERSPORT 800 S	03	•
803	SUPERSPORT 800 SS	03	•
848	848	08	•
900	MH 900 EVOLUZIONE	01 > 02	•
900	MONSTER 900 i.e./900 S i.e./DARK i.e.	00	•
900	METALLIC i.e., CROMO i.e.	00	•
900	MONSTER 900 S i.e., DARK i.e.,	01	•
900	METALLIC i.e., CROMO i.e.	01	•
900	MONSTER 900, DARK i.e.	02	•
900	SPORT TOURING 4	99	•
900	SUPERSPORT 900	98 > 99	•
900	SUPERSPORT 900 i.e.	00 > 02	•
900	SUPERSPORT 900 S i.e.	02	•
916	916 SPS	98	•
916	MONSTER S4, S4 FOGGY	02 > 03	•
916	SPORT TOURING 4	00 > 03	•
916	SPORT TOURING 4	99	•
916	SPORT TOURING 4 S	03 > 04	•
916	SPORT TOURING 4 S (ABS)	03 > 04	•
944	SPORT TOURING 2	99 > 00	•
992	MONSTER 1000	04 > 05	•
992	MONSTER 1000 S	05	•
992	MONSTER 1000 S i.e.	03	•
992	MONSTER S2 R 1000	06	•
992	MULTISTRADA 1000 DS	03	•
992	MULTISTRADA 1000 S DS	05	•
992	ST3	04	•
992	ST3 ABS, ST3 S ABS	07	•
992	ST4, ST4 ABS	05	•
992	SUPERSPORT 1000	06	•
992	SUPERSPORT 1000 DS	05	•
992	SUPERSPORT 1000 S	03	•
996	996, 996 S	01	•
996	996, 996 S, 996 SPS, 996 SPS III	00	•
996	996, 996 SPS, 996 SPS II	99	•
996	MONSTER S4 R	04	•
996	MONSTER S4 R	03	•
998	998	02	•
998	998 Matrix	04	•
1078	MULTISTRADA 1100	07	•
1078	MULTISTRADA 1100 S	07	•
1100	HYPERMOTARD	07	•

1100	MONSTER 1100	09	•
1100	MONSTER 1100 S	09	•

HUSQVARNA

570	NOX	01 > 03	•
610	LT	00	•
610	SM	98 > 99	•
610	SMS	00 > 01	•
610	SMS	03 > 04	•
610	TE E LT	00	•
630	SMR	04	•

KTM

625	SMC	05	•
640	DUKE II	05 > 07	•
640	DUKE II	99 > 04	•
640	LC4 SUPERMOTO	05	•
660	SMC	04	•
660	SMC	06	•
690	SUPERMOTO	07	•

MOTO GUZZI

750	BREVA 750 i.e.	03 > 06	•
750	NEVADA	03	•
750	NEVADA CLASSIC i.e.	06	•
850	BREVA 850	06	•
850	GRISO 850	06	•
1100	BREVA	05	•
1100	CALIFORNIA ALL, TITANIUM	03	•
1100	CALIFORNIA CLASSIC, TOURING	06	•
1100	CALIFORNIA EV	01 > 05	•
1100	CALIFORNIA EV	06	•
1100	CALIFORNIA EV TOURING	04	•
1100	CALIFORNIA EV, EV TOURING	03	•
1100	CALIFORNIA EV, SPORT	01 > 02	•
1100	CALIFORNIA JACKAL	99 > 01	•
1100	CALIFORNIA JACKAL BASIC	01	•
1100	CALIFORNIA SPECIAL	01	•
1100	CALIFORNIA SPECIAL SPORT	02	•
1100	CALIFORNIA SPECIAL SPORT/ALUMINIUM	02	•
1100	CALIFORNIA STONE	01 > 05	•
1100	CALIFORNIA STONE, METAL	02	•
1100	CALIFORNIA VINTAGE	07	•

1100	GRISO	05	•
1100	SPORT	01	•
1100	V11 CAFE SPORT / BALLABIO	03	•
1100	V11 COPPA ITALIA	04	•
1100	V11 LE MANS	01	•
1100	V11 LE MANS / NAKED	03	•
1100	V11 LE MANS / NAKED / SPORT	01 > 02	•
1100	V11 SCURA	02	•
1100	V11 SPORT ROSSO	01	•
1200	1200 SPORT 4V	09	•
1200	GRISO 8V	07	•
1200	NORGE, ABS	06	•
1200	SPORT	06	•
1200	SPORT ABS	06	•
1200	STELVIO	08	•

MOTO MORINI

950	9 1/2	06	•
1200	1200 SPORT	09	•
1200	CORSARO	06	•

MV AGUSTA

989	BRUTALE R	08	•
-----	-----------	----	---

MZ

1000	MUZ S	01 > 02	•
------	-------	---------	---

SACHS

500	MADASS	05	•
-----	--------	----	---

SUZUKI

1200	GSX	99 > 01	•
------	-----	---------	---

VOXAN

1000	EVO	04	•
------	-----	----	---

YAMAHA

400	XJR R	95	•
660	XT X	04	•
850	TRX	95	•
1200	XJR ITALIA	95 > 98	•





07BB20.7A 50,8x 53,7x 7,8
GENUINE

07BB20.18 50,8x53,7x 7,4
GENUINE

07BB20.3A " " "
GENUINE

07BB20.35 " " "
GENUINE

07BB20.65 " " "
GENUINE

07BB20.9A " " "
GENUINE

07BB20.30 50,8x53,7x 7
GENUINE

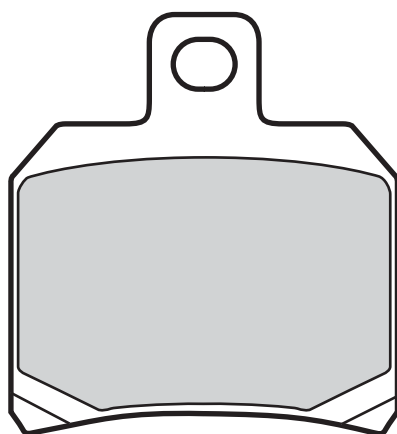

2



APRILIA

1000 BLU MARTIN	02	•
1000 ETV CAPO NORD	01 > 03	•
1000 ETV CAPO NORD ABS	04	•
1000 ETV CAPO NORD RALLY RAID	04	•
1000 RSV	02	•
1000 RSV	97 > 01	•
1000 RSV FACTORY	04	•
1000 RSV NERA	04	•
1000 RSV R	00	•
1000 RSV R	01 > 03	•
1000 RSV SL FALCO	00 > 04	•
1000 RSV SP	99	•
1000 RSV4 FACTORY	09	•
1000 TUONO FIGHTER	03	•
1000 TUONO R	03	•
1000 TUONO RACING	04	•

BENELLI

899 TNT	07	•
900 TORNADO 3	03	•
1130 TNT	05	•
1130 TNT CAFE' RACER	05	•
1130 TNT SPORT	05	•
1130 TNT TITATIUM	05	•
1130 TORNADO TRE	06	•

BIMOTA

1100 TESI 3D	07	•
--------------	----	---

CAGIVA

650 RAPTOR	01 > 05	•
650 V-RAPTOR	01 > 05	•
1000 RAPTOR	00	•
1000 V-RAPTOR	00	•
1000 X3 RAPTOR	04	•
1000 X-RAPTOR	03	•
1000 XTRA RAPTOR	02	•

DUCATI

620 MULTISTRADA 620 DS	03	•
696 MONSTER 696	08	•
696 MONSTER 696	08	•
696 MONSTER 696 / 696 +	09	•
748 749	03 > 07	•
748 749 DARK	05 > 06	•
748 749 R	03 > 07	•
748 749 S	03 > 07	•
848 848	08	•
900 MH 900 EVOLUZIONE	01 > 02	•
990 DESMOSEDICI RR (D16RR)	07	•
992 MULTISTRADA 1000 DS	03	•
992 MULTISTRADA 1000 S DS	05	•
998 999	03 > 07	•
998 999 R	03 > 07	•
998 999 S	03 > 07	•
998 999 XEROX	06	•
1078 MULTISTRADA 1100	07	•
1078 MULTISTRADA 1100 S	07	•
1098 1098 R BAYLISS	09	•
1098 STREETFIGHTER	09	•

1098 STREETFIGHTER S	09	•
1099 1098	07	•
1099 1098 S	07	•
1099 1098 S Tricolore	07	•
1100 HYPERMOTARD	07	•
1100 HYPERMOTARD S	07	•
1100 MONSTER 1100	09	•
1100 MONSTER 1100 S	09	•
1198 1098 R	08	•
1198 1198	09	•
1198 1198 S	09	•

KTM

1190 RC8	08	•
1190 RC8 1190	09	•
1190 RC8 1190 R	09	•

LAVERDA

1000 SFC 1000 L.E.	03	•
--------------------	----	---

MONDIAL

1000 PIEGA	02	•
1000 PIEGA EVO	04	•
1000 PIEGA RZ NUDA	04	•

MOTO MORINI

950 9 1/2	06	•
1200 1200 SPORT	09	•
1200 CORSARO	06	•





07BB21.SA 57,6x 56,6x 8,9
07BB21.07 " " "

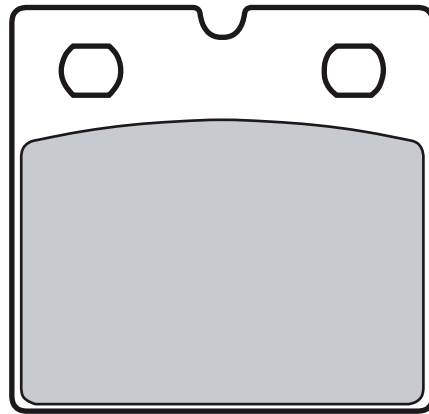

2

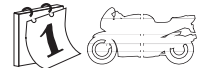
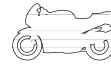
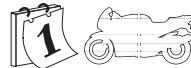
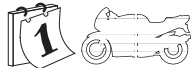

BMW

750 K 75 ABS (special caliper)	91	•
750 K 75 RT	91	•
1000 K 100 ABS (special caliper)	91	•



07BB22.SA 99,6x 55,6x 8,3
07BB22.07 " " "

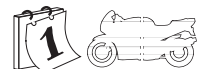
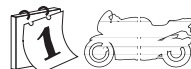
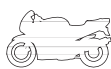
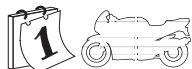
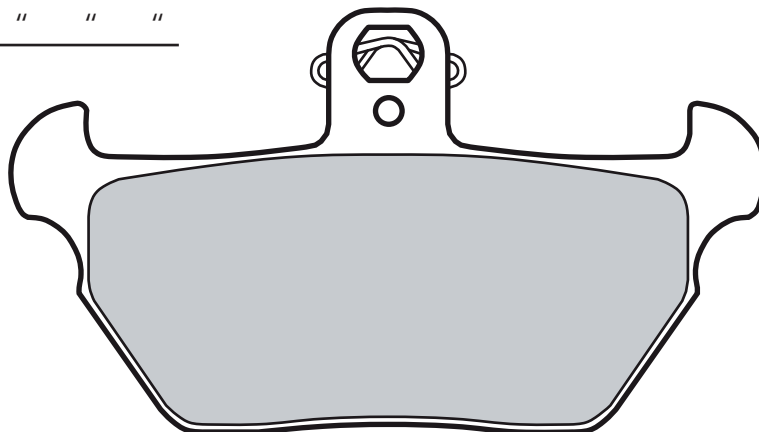

BMW

800 R 80 R	92	•
1000 K 1	89	•
1000 K 100 LT	92	•

1000 K 100 RS 16V.	90	•
1000 R 100 R	91	•
1000 R 100 R	92	•
1100 K 1100 LT	92	•

1100 K 1100 RS	93	•
1100 R 1100 RS	93	•





07BB23.07 59,7x 58,5x 9

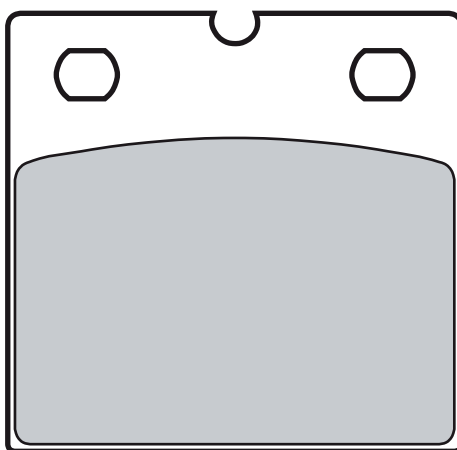

2



BENELLI

900 SEI	78	•
---------	----	---

BMW

800 R 80 GS	88	
1000 R 100 GS	88	•

MOTO GUZZI

850 850 LE MANS	76 > 80	•
850 850 T3 CALIFORNIA	76	•
850 850 T3 GERMANIA	75	•
1000 CALIFORNIA II	83 > 86	•
1000 GS CONVERT GERMANIA	75	•

1000 SP 1000	78	•
--------------	----	---

TRIUMPH

750 BONNEVILLE	84	•
----------------	----	---





07BB24.SA 100x 56,1x 8,4
07BB24.07 " " "

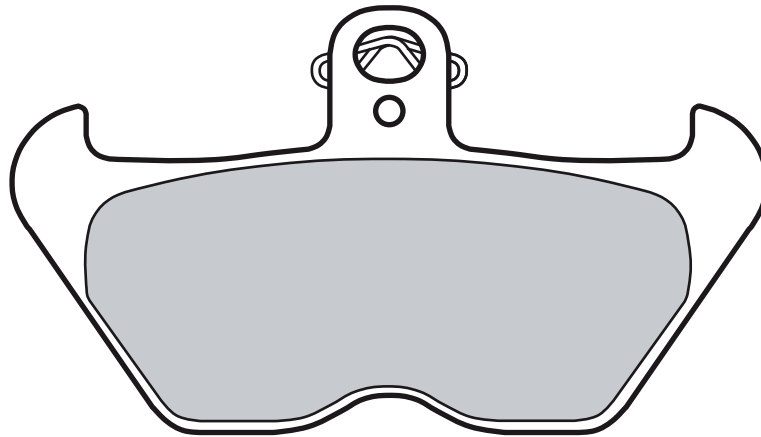

2

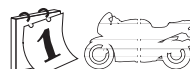
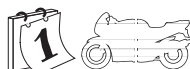

BMW

850 R 850 C	99	•
850 R 850 GS	99	•
850 R 850 R	96 > 02	•
850 R 850 RT	98 > 00	•

1100 R 1100 GS, RS	94	•
1100 R 1100 R	95	•
1100 R 1100 R	99	•
1100 R 1100 RT	95	•
1100 R 1100 S	99 > 00	•

1150 R 1150 GS	00 > 01	•
1200 K 1200 LT	99 > 00	•
1200 K 1200 RS	97 > 00	•
1200 R 1200 C	98 > 02	•





07BB25.07 74,9x 54,6x 8,9

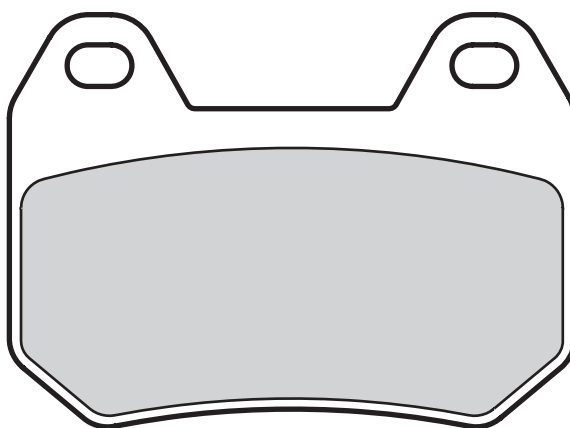

2

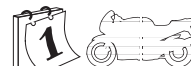

BMW

1200 K 1200 LT	99 > 00	•
1200 K 1200 LT ABS	01	•



07BB26.SA 77x 51,4x 8,6

07BB26.SC " " "

07BB26.07 " " "

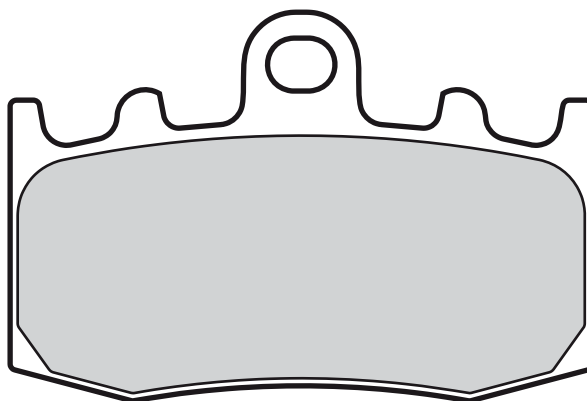

BMW

850 R 850 RT ABS	01	•
1100 R 1100 S	01	•
1150 R 1150 GS, ADVENTURE	02	•
1150 R 1150 RT	01	•
1200 HP2 Megamoto	07	•
1200 K 1200 GT ABS	02 > 08	•

1200 K 1200 RS	01	•
1200 K 1200 S	05 > 08	•
1200 R 1200 GS	04	•
1200 R 1200 GS ADVENTURE	06	•
1200 R 1200 RT	05	•
1200 R 1200 S	06	•
1200 R 1200 ST	06	•

1300 K 1300 GT	09	•
1300 K 1300S	09	•





07BB27.SD	64x 41,8x 9
07BB27.SX	" " "
07BB27.TT	" " "
07BB27.5A	64x 41,8x 9
G E N U I N E	64x 41,8x 11

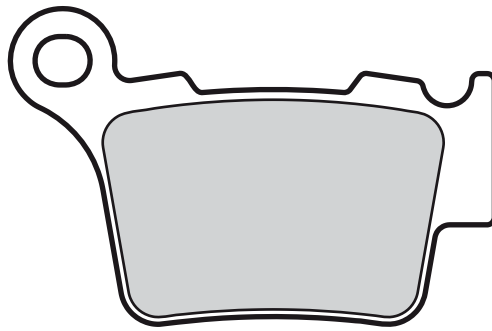

2

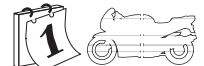
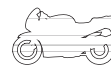
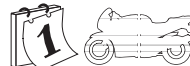
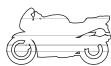
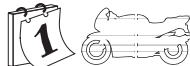
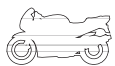
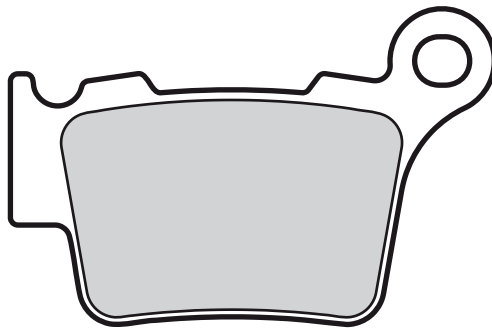

BMW

450 G 450 SMR	09	•
450 G 450 X	09	•

HUSABERG

450 FE	09	•
570 FE	09	•

HUSQVARNA

125 CR	05	•
125 WR	05	•
250 CR	05	•
250 SMR	06	•
450 SMR	06	•
450 SMR R	06	•
450 TC	04	•
450 TE	06	•
510 SM CENTENNIAL	06	•
510 SMR	06	•
510 TC	05	•
510 TE	06	•
510 TE CENTENNIAL	04	•

KTM

125 EXC	04	•
125 SX	04	•
144 SX	07 > 08	•
150 SX	09	•
200 EXC	04	•
200 SX	04	•
250 EXC	04	•
250 EXC RACING	05	•
250 EXC-F	06	•
250 SX	03	•
250 SXC	03	•
250 SX-F	06	•
300 EXC	04	•
300 SX	06	•
400 EXC RACING	05	•
450 450 XC-F	08	•
450 EXC	04	•
450 EXC RACING	05 > 06	•
450 EXC RACING	07	•
450 SM FACTORY REPLICA	04	•
450 SMR	04 > 06	•
450 SMR	07	•

450 SMR	04	•
450 SX	04	•
450 SX RACING	05	•
450 SX-F	07	•
505 505 XC-F	09	•
505 SX-F	07	•
525 EXC	04	•
525 EXC RACING	05	•
525 SMR	05	•
525 SMR	04	•
525 SX	04	•
525 SX RACING	05	•
525 XC DESERT RACING	04	•
530 EXC	08	•
530 EXC RACING	09	•
560 SMR	06	•
660 SMC	04	•

RIEJU

450 MRX	08	•
---------	----	---





07BB28.SP 94x 36,2x 8,6
94x 36,2x 10,1

07BB28.09 " " "

2

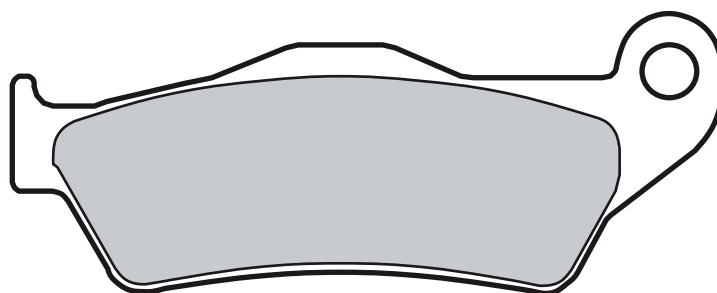

BMW

850 R 850 C	99	•
850 R 850 GS	99	•
850 R 850 R	03	•
850 R 850 R	96 > 02	•
850 R 850 RT	98 > 00	•
850 R 850 RT ABS	01	•
1100 R 1100 GS, RS	94	•
1100 R 1100 R	95	•
1100 R 1100 R	99	•
1100 R 1100 RT	95	•
1100 R 1100 S	01	•
1100 R 1100 S	99 > 00	•

1100 R 1100 S ABS	01	•
1150 R 1150 GS	00 > 01	•
1150 R 1150 GS, ADVENTURE	02	•
1150 R 1150 R	01	•
1150 R 1150 R ROCKSTER	02	•
1150 R 1150 RS	01	•
1150 R 1150 RT	01	•
1150 R 1150 S	03	•
1200 HP2 Megamoto	07	•
1200 K 1200 R	07	•
1200 K 1200 R	05	•
1200 K 1200 R Sport	07	•
1200 K 1200 S	05 > 08	•

1200 R 1200 C	03	•
1200 R 1200 C	98 > 02	•
1200 R 1200 GS	04	•
1200 R 1200 GS ADVENTURE	06	•
1200 R 1200 R	07	•
1200 R 1200 RT	05	•
1200 R 1200 S	06	•
1200 R 1200 ST	06	•
1300 K 1300 GT	09	•
1300 K 1300 R	09	•
1300 K 1300S	09	•





07BB30.RC 102,2x 42x 7,4

07BB30.59 " " "
G E N U I N E

07BB30.90 " " "
G E N U I N E

07BB30.93 " " "
G E N U I N E

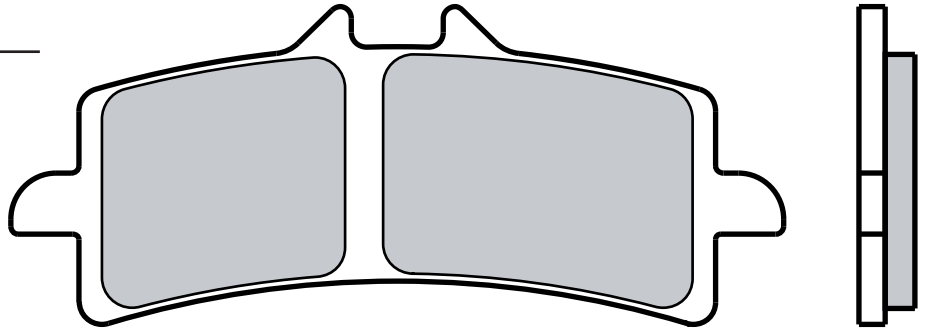

2

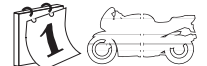
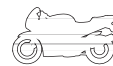
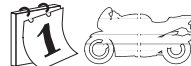
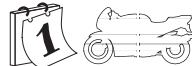

APRILIA

1000 RSV4 FACTORY 09 •

BMW

1200 HP2 Sport 08 •

DUCATI

990 Desmosedici RR (D16RR) 07 •

1098 1098 R BAYLISS 09 •

1098 STREETFIGHTER 09 •

1098 STREETFIGHTER S 09 •

1099 1098 07 •

1099 1098 S 07 •

1099 1098 S Tricolore 07 •

1100 HYPERMOTARD S 07 •

1198 1098 R 08 •

1198 1198 09 •

1198 1198 S 09 •

KTM

990 LC8 990 SUPERMOTO R 09 •

1190 RC8 08 •

1190 RC8 1190 09 •

1190 RC8 1190 R 09 •

MV AGUSTA

1078 BRUTALE 1078 RR 09 •

1078 BRUTALE RR 08 •

1078 F4 CC 08 •

1078 F4 RR 312 08 •





07BB31.35 39,8x 56,2x 7,9
GENUINE

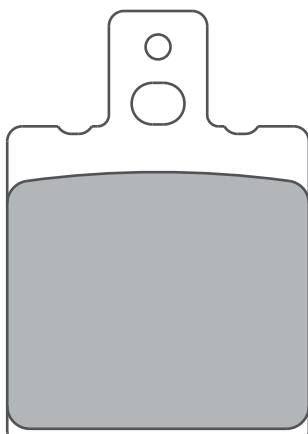

2

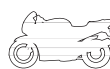
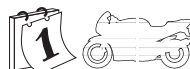
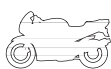
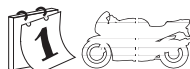
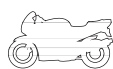

ALFER

80	MC	87	•
125	MC	87	•
125	MC	88	•
250	GR ENDURO	85	•
250	GR ENDURO	88	•
250	MC	85	•
250	MC	87	•
250	MC	88	•
300	GR	85	•
300	GR ENDURO	88	•

APRILIA

50	TUONO	04	•
125	CLASSIC	96	•
125	ETX	86 > 87	•
125	RED ROSE	89	•
125	RED ROSE	90	•
125	RS	99 > 05	•
125	RS PISTA	04 > 05	•
125	SPORT PRODUCTION	92	•
125	TUONO	04	•
200	CLIMBER	93	• •
250	TUAREG RALLY	86	•
350	ETX	86	•
600	ETX	86	•
600	TUAREG	86 > 87	•
600	TUAREG WIND	88 > 89	•

BENELLI

125	2C 4-stroke		•
125	BX	89	•
125	BXK	88	•
125	CUSTOM	85	•
125	JARNO	89	•

350	354 TURISMO, SPORT	83	•
900	TORNADO 3	00 > 02	•
1100	TNT	04	•

BETA

50	KR TWIN	88	• •
50	S02	97	•
50	TEMPO	97 > 98	•
250	GS, RV	82	•
260	ALP	96	•
500	GS, RV	82	•

BIMOTA

500	V due	97	•
650	SUPERMONO BIPOSTO	97	•
750	SB7	94	•
900	DB4	99	•
900	MANTRA	97	•
1000	SB8 K SANTAMONICA	06	•
1000	SB8 K SANTAMONICA	07	•
1000	SB8 R	98	•
1000	YB 11	97	•
1100	SB6	97	•

CAGIVA

50	PRIMA	92	• •
50	SUPER CITY	92	• •
80	SUPER CITY	92 > 93	• •
80	SUPER CITY	94	•
125	BLUES	89 > 93	•
125	DAKAR	89 > 90	•
125	FRECCIA C10	88 > 89	•
125	FRECCIA C10 ANNIVERSARY	89	•
125	FRECCIA C12	89	•
125	FRECCIA C9	88	•

125	K 7	90	•
125	N1	96	•
125	SP MITO 525	08	• •
125	SUPER CITY	92	•
200	ELEFANT	85 > 87	•
350	ALA AZZURRA	83	• •
350	ALA BLU	83	•
350	ALA VERDE	83	•
350	W12	92	•
500	CROSS	80	•
750	LUCKY EXPLORER	88	•

DB MOTORS

50	ZZ PIRAT	00	•
50	ZZ SPORT	00	•

DERBI

125	Mulhacén	07 > 07	•
-----	----------	---------	---

DUCATI

350	F3	88	• •
350	SUPERSPORT 350	92	•
350	XL	82	•
400	MONSTER 400	95 > 97	•
400	MONSTER 400 (Monodisco)	05	•
400	MONSTER 400 DARK	03	•
400	SUPERSPORT 400	93 > 97	•
500	502 SINGLE	93	•
500	502 SUPERMONO	93	•
600	MONSTER 600	93 > 97	•
600	MONSTER 600 CITY, DARK CITY	99	•
600	MONSTER 600 METALLIC	00 > 01	•
600	MONSTER 600, DARK	98	•
600	MONSTER 600, DARK, DARK CITY	00	•
600	SUPERSPORT 600	91 > 97	•



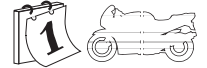
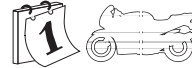
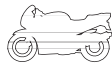
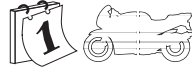

620	MONSTER 620 (Bidisco)	05	•
620	MONSTER 620 DARK (Monodisco)	04	•
620	MONSTER 620 DARK (Monodisco)	05	•
620	MONSTER 620 i.e. DARK	02	•
620	MONSTER 620 i.e./620 S i.e.	02	•
620	MONSTER 620 i.e./620 S i.e./DARK	03	•
620	MONSTER 620, DARK	04	•
620	MULTISTRADA 620 (Bidisco)	05	•
620	MULTISTRADA 620 DARK (Monodisco)	05	•
650	SL	84	•
695	MONSTER 695	06	•
748	748 BIPOSTO	95 > 97	•
748	748 SP	95 > 97	•
750	F1	86	•
750	INDIANA	89	•
750	MONSTER 750 (bidisco)	96 > 98	•
750	MONSTER 750 (monodisco)	96 > 97	•
750	MONSTER 750 CITY, DARK CITY	99	•
750	MONSTER 750 DARK i.e.	02	•
750	MONSTER 750, METALLIC, DARK	00 > 01	•
750	SPORT	74 > 76	•
750	SUPERSPORT 750	91 > 98	•
803	MONSTER 800	04	•
803	MONSTER 800 S i.e.	03	•
803	MONSTER S2 R	05	•
803	MONSTER S2 R DARK	05	•
888	888 SP4	92	•
888	888 SP5	93	•
888	888 SUPERBIKE STRADA	94 > 95	•
888	SPORT PRODUCTION	92	•
900	FE	97	•
900	MONSTER 900	93 > 99	•
900	MONSTER 900 CITY, DARK CITY	99	•
900	MONSTER 900 CROMO	98	•
900	MONSTER 900 i.e./900 S i.e./DARK i.e.	00	•
900	METALLIC i.e., CROMO i.e.	00	•
900	MONSTER 900 S i.e./DARK i.e.	01	•
900	METALLIC i.e., CROMO i.e.	01	•
900	MONSTER 900 SPECIAL	98	•
900	MONSTER 900, DARK i.e.	02	•
900	SUPERLIGHT 900	92 > 97	•
907	i.e.	92	•
916	MONSTER S4, S4 FOGGY	02 > 03	•
992	MONSTER 1000	04 > 05	•
992	MONSTER 1000 S	05	•
992	MONSTER 1000 S i.e.	03	•
992	MONSTER S2 R 1000	06	•
996	MONSTER S4 R	04	•
998	MONSTER S4 R Testastretta	07	•
998	MONSTER S4 RS Testastretta	06	•

FANTIC MOTOR

250	COACH	91	•
-----	-------	----	---

GARELLI

50	TIGER XLE	86	• •
50	URKA	91	•

GILERA

50	SIOUX	92	• •
125	ARIZONA	83	•
125	CHRONO	91	•
125	CX	91	•
125	FAST BIKE	88	•
125	FREESTYLE	92	•
125	MX	83	•
125	MX1	88	•
125	R1	88	•
125	SP 01, SP 02	89	•
125	XR1, XR2	88	•
200	ARIZONA	85	•
200	FAST BIKE	88	•
200	RV	85 > 86	•
200	RV	86	•
250	MX LC	83	•
350	DAKOTA	89	•
350	XRT	89	•
500	DAKOTA	86	•
600	NORDWEST	90	•
600	XRT	89	•

HONDA

50	CRE	93	•
----	-----	----	---

HRD

125	STRADA	83	• •
-----	--------	----	-----

HUSQVARNA

125	CX	84 > 85	•
400	ENDURO	85	•
430	ENDURO	85	•
500	CR	84 > 86	•
500	CX	84 > 85	•
500	TC	86	•
510	TE	86	•
540	504	83	•

ITALJET

350	350	83	•
-----	-----	----	---

KTM

50	MX	91	•
----	----	----	---

80	MX	91	•
85	MX	90	•
125	MX	86	• •

LAVERDA

50	ATLAS	86	• •
50	GAUCHO	92	• •
125	FL	82	•
650	FORMULA	94 > 95	•
650	GHOST	96	•
650	SPORT	94 > 95	•
650	STRADA	96	•
668	668	96	•
668	DIAMANTE	96 > 98	•
668	GHOST STRIKE LEGEND	96 > 98	•
750	750 S SPORT	99 > 00	•
750	CUP	98	•
750	DIAMANTE	97	•
750	GHOST STRIKE	97	•
750	S FORMULA	99 > 00	•
750	S, S SCARENATO	97 > 98	•
750	STRIKE BIFARO	98 > 99	•
750	STRIKE MONOFARO	98 > 99	•
750	T8	98	•

MAICO

250	GM LC	85	•
-----	-------	----	---

MALAGUTI

50	ENDURO	85	•
50	MRX	89	•
50	RST	89	• •

MONTESA

260	EVASION	92	•
309	COTA	89	•
310	COTA	89	•
311	COTA TRIAL	92	•

MOTO GUZZI

125	BX	92	• •
125	CUSTOM	85	•
125	ENDURO TT	85	•
250	TS	75 > 76	•
350	FALCO	88	• •
350	IMOLA	78	• •
350	NEVADA	92	• •
350	NTX	88 > 89	•
350	NTX	90	•
350	V 35 FLORIDA	87	•
400	400	77	• •



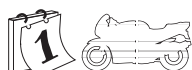

650	NTX	87	•
650	V 65	86	•
650	V 65 FLORIDA, LARIO	87	•
650	V 65 TT	84	• •
750	NEVADA	92 > 96	•
750	NEVADA	97 > 02	• •
750	NTX	89	•
750	TARGA	89	•
1000	V	93	•

MOTO MORINI

250	COUNTRY	88	•
350	COGUARO, NEW YORK	89	•
350	INDIANA	88	•
350	KANGURO	87	•
501	KANGURO	87	•
501	NEW YORK	89	•
650	INDIANA	88	•
750	INDIANA	88	•

MZ

660	SKORPION CUP MUZ	99	•
660	SKORPION REPLICA MUZ	97	•
660	SKORPION SPORT MUZ 95 > 99	•	•
660	SKORPION TOUR MUZ 95 > 99	•	•
660	SKORPION TRAVELLER MUZ	99	•

OSSA

500	YANQEE	78	•
-----	--------	----	---

SACHS

80	LOTUS SW	•	•
----	----------	---	---

SIMSON

50	HABICT	01	•
50	SPATZ	99	•
50	SPERBER	99	•
80	SR	•	•

SWM

125	GP	86	• •
125	S1-S2	•	•
250	EXPLORER	86	• •
250	PIONER	86	• •
250	S1-S2	•	•
329	TRL	86	•

YAMAHA

125	TDR R ITALIA	92	•
125	TZR R ITALIA	92	•
660	SZR	96	•





07BB32.35 50,8x 53,7x 7,9
GENUINE

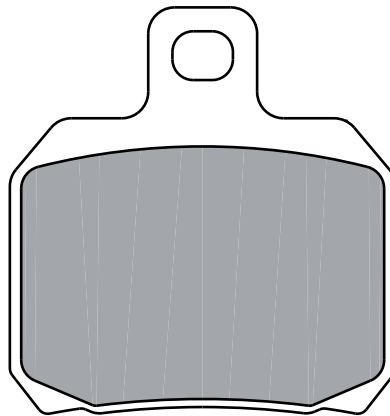

2

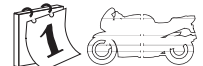
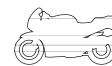
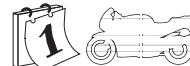
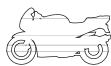
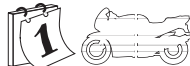
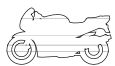

BENELLI

756 CUE	07	•
899 TRE 899 K	09	•
1130 TRE-K	06	•

BIMOTA

1000 DB5	05	•
1000 DB5	07	•
1000 DB6 DELIRIO	06	•
1098 DB7	08	•
1100 DB6 R DELIRIO	08	•

DERBI

50 GPR NUDE	04	•
50 GPR RACING	04	•
125 GP1	05	•
659 MULHACÉN	06	•
659 MULHACÉN CAFÉ	08	•

DUCATI

620 SUPERSPORT 620 S	03	•
750 SPORT	00	•
750 SUPERSPORT 750	99	•
750 SUPERSPORT 750 i.e. 00 > 02		•
750 SUPERSPORT 750 S i.e. 02		•

803 SUPERSPORT 800	06	•
803 SUPERSPORT 800 S	03	•
803 SUPERSPORT 800 SS	03	•
900 SPORT TOURING 4	99	•
900 SUPERSPORT 900	98 > 99	•
900 SUPERSPORT 900 i.e. 00 > 02		•
900 SUPERSPORT 900 S i.e. 02		•
916 SPORT TOURING 4	00 > 03	•
916 SPORT TOURING 4	99	•
916 SPORT TOURING 4 S	03 > 04	•
916 SPORT TOURING 4 S (ABS)	03 > 04	•
944 SPORT TOURING 2	99 > 00	•
992 ST3	04	•
992 ST3 ABS, ST3 S ABS	07	•
992 ST4, ST4 ABS	05	•
992 SUPERSPORT 1000	06	•
992 SUPERSPORT 1000 DS	05	•
992 SUPERSPORT 1000 S	03	•

LAVERDA

800 TTS	99	•
---------	----	---

MALAGUTI

500 SPIDERMAX GT	04	•
500 SPIDERMAX RS 500	09	•

MONDIAL

1000 STARFIGHTER RZ	04	•
---------------------	----	---

MOTO GUZZI

750 BREVA 750 i.e.	03 > 06	•
750 NEVADA	03	•
750 NEVADA CLASSIC i.e.	06	•
1200 MGS-01 CORSA	05	•

RIEJU

50 SMX PRO	08	•
50 TANGO	08	•
125 MARATHON PRO	09	•
125 MARATHON PRO SUPERMOTARD	09	•
125 TANGO	08	•
125 TANGO PRO	08	•
250 TANGO	08	•

VOXAN

1000 CAFE RACER	01	•
1000 EVO	04	•
1000 ROADSTER	01	•





07GR01.01 31,2x 49x 5,6

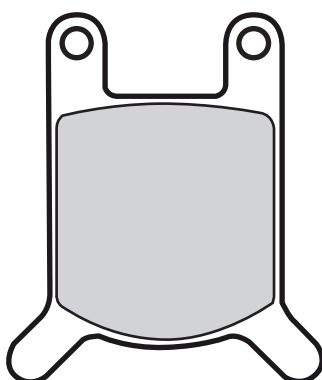

2



BENELLI

250 254 83 •

BETA

50 MG 83 •
50 SQUIRREL 83 •

CASAL

50 RZ •

FANTIC MOTOR

50 SUPER SIX 83 •

GARELLI

40 S SPORT •
80 SPORT 83 •

HERCULES

50 RS 79 > 83 •
50 ULTRA 79 > 83 •
80 AC CHOP 81 > 83 •
80 CHOPPER 81 •
80 RX 9 82 > 83 •
80 RX 9 air cooled 82 > 83 •
80 ULTRA 81 •

80 ULTRA CHOPPER AC 81 > 83 •

HOREX

80 REBELL N •
80 REBELL T 86 •
80 SPORT L 86 •

MALAGUTI

25 CHOPPER 86 •
40 CHOPPER 83 •
50 FIFTY HF WC 83 •
50 RONCO 83 •
50 SPORT XL 83 •
50 V4 OLIPIQUE 83 •
80 CHOPPER 83 •
125 RUNNER 86 •

MOTO GUZZI

125 T 81 •

OSSA

350 TU-YO •

PUCH

50 COBRA 6 GT, GTL 80 •

50 MONZA 4 SL, GSL 80 •

RIEJU

80 NEVADA SPORT •

SACHS

80 LOTUS SA •

ZUNDAPP

50 KS SUPER SPORT 79 •
50 KS TT 80 > 81 •
80 KS SUPER 83 •
80 KS TOURING 80 •
175 KS 78 •

ZWEIRAD ROTH

50 REBEL SPORT •
80 REBEL SPORT •





07GR02.04 49x 58x 7,1

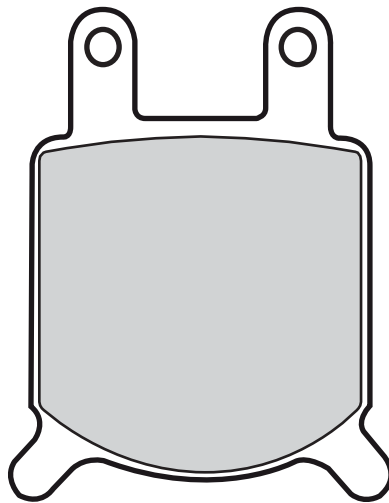

2

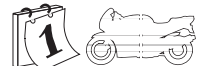
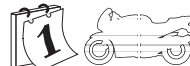
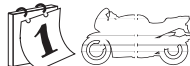

ASPES

125 JUMA 76 •

BETA

125 TS, CUSTOM 83 •

250 CUSTOM 82 •

FANTIC MOTOR

125 SPORT HP1 86 •

GARELLI

125 GTA 86 •

125 TSR 83 •

GILERA

80 TG1 83 •

125 GR1 85 •

125 RV 86 •

125 TG1 85 •

200 RV 86 •

200 T4, T4C, T4S 85 •

KREIDLER

125 MUSTANG 83 •

LAVERDA

125 125 80 •

MOTO MORINI

125 STRADA •

250 STRADA •

250 TT 86 •

350 K2 84 •

350 SPORT 80 • •

350 STRADA •

350 TT 80 •

500 STRADA •

500 TT 80 •

ZUNDAPP

80 KS 80 •

125 KS 79 > 81 •





07GR03.CC 98,1x32,6x 7,6
110,8x35,7x 7,6

2

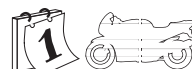
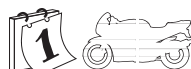
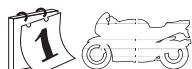
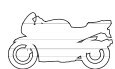
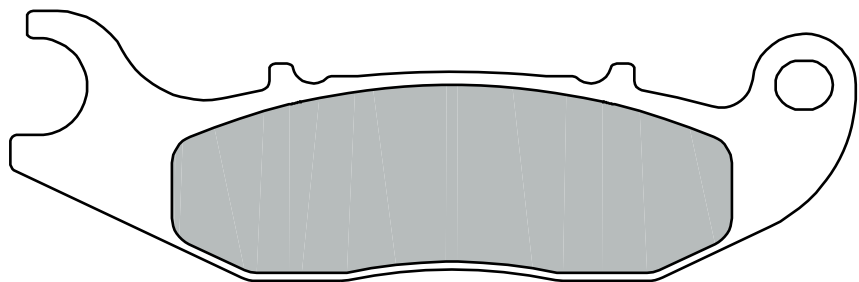
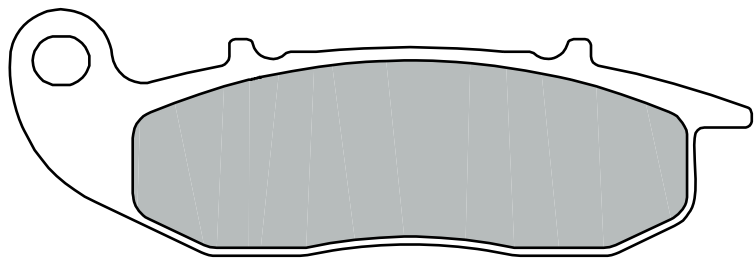

DERBI

125	Mulhacen	08	•
125	Terra	08	•
125	Terra Adventure	08	•

SCORPA

250	T-Ride	08	•
-----	--------	----	---





07GR05.CC 65,7x 36,7x 8,4

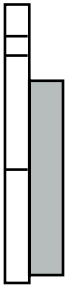
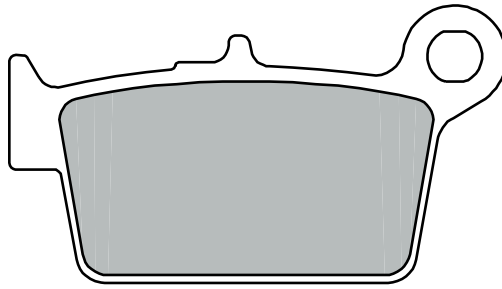

2

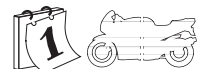
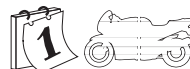
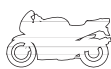
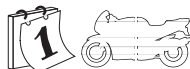
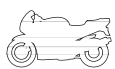
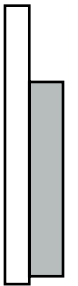
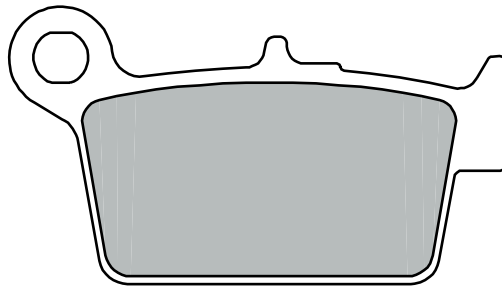

BETA

50	RR SUPERMOTARD	08	•
125	ALP 4-stroke (EBE)	06	•
125	M4 (EBE)	06	•

200	ALP 4-stroke (EBE)	06	•
350	ALP 4.0 (EBE)	06	•
350	M4 (EBE)	06	•





07GR06.SA 78,1x 46,2x 7,8

07GR06.SC " " "

07GR06.RC " " "

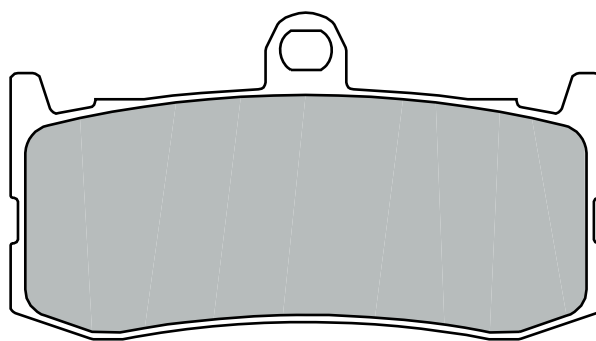

2



TRIUMPH

675 DAYTONA TRIPLE 675 09 •



07GR07.SD 76,4x 38x 6,9

07GR07.SX " " "

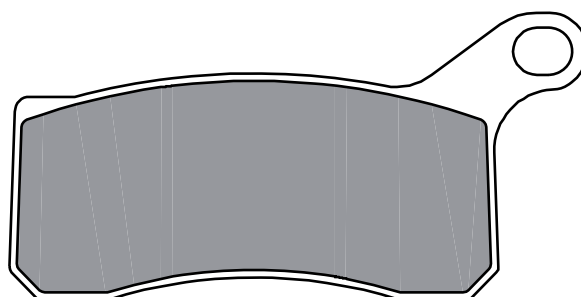
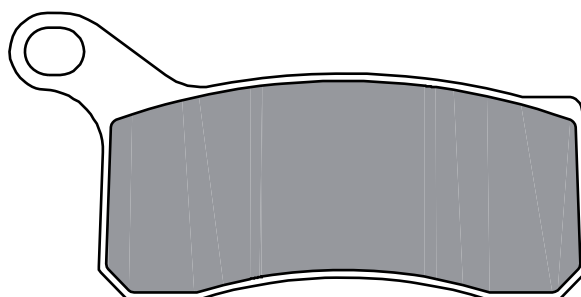

KTM

450 SX ATV 08 •

450 XC ATV 08 •

505 SX ATV 08 •

505 XC ATV 08 •





07GR08.SD 58,7x 35,3x 8,2
07GR08.SX " " "

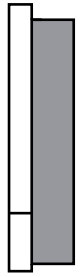
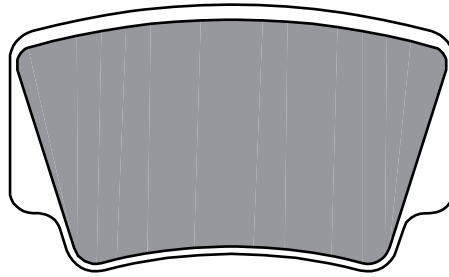

2

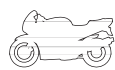
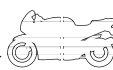
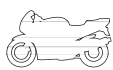
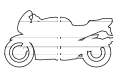

KTM

450	SX ATV	08	•
450	XC ATV	08	•
505	SX ATV	08	•
505	XC ATV	08	•





07GR09.CC 88,2x48,9x 7,8
55,6x35,9x10,3

2

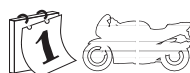
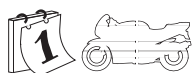
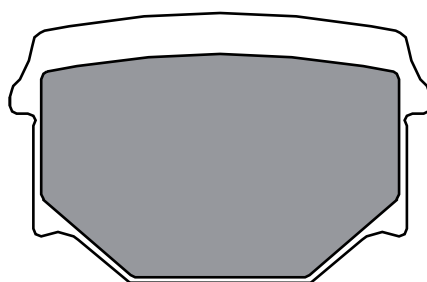
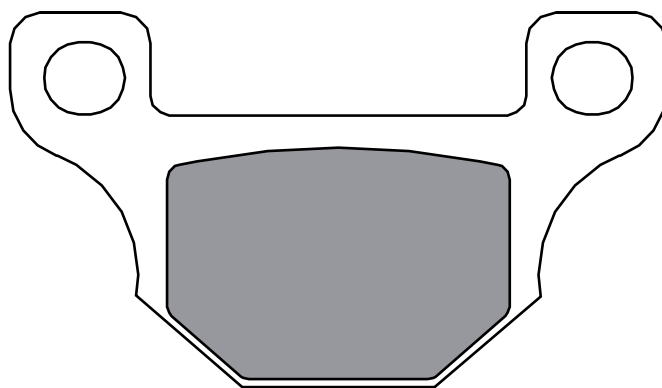

DERBI

125	Mulhacen	08	•
125	Terra	08	•
125	Terra Adventure	08	•

KEEWAY

125	SPEED	06	•
150	SPEED	06	•

RIEJU

50	MRT	09	• •
----	-----	----	-----

50	MRT SUPERMOTARD	09	• •
50	SPIKE X	08	• •
125	MARATHON PRO	09	•
125	MARATHON PRO SUPERMOTARD	09	•

SUZUKI

125	GN	05	•
125	GN Z, E	82 > 90	•
125	GS E, KATANA	90 > 94	•
125	GS ESD	83 > 94	•

TGB

50	BULLET	09	•
50	CORONA	03	•
50	RX	06	•





07GR10.01 43,4x 64,4x 7

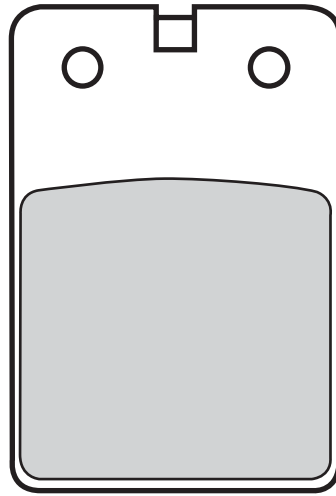

2

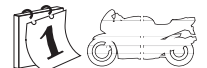
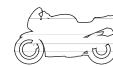
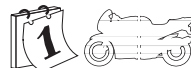
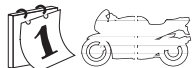

FANTIC MOTOR

125 SPORT	84 > 85	•
125	84	•

GILERA

125 RV	83	•
200 RV	85 > 86	•

MOTO MORINI

400 S	84	•
500 6 V CLASSIC	89	•





07GR11.CC 84,7x36,6x 7,9
47,7x31,4x12,2

2

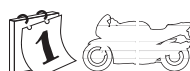
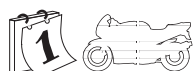
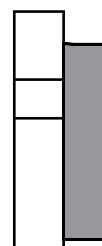
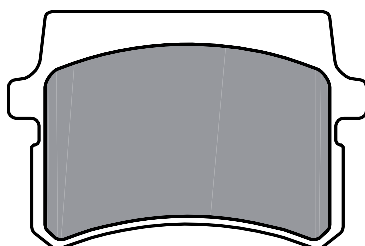
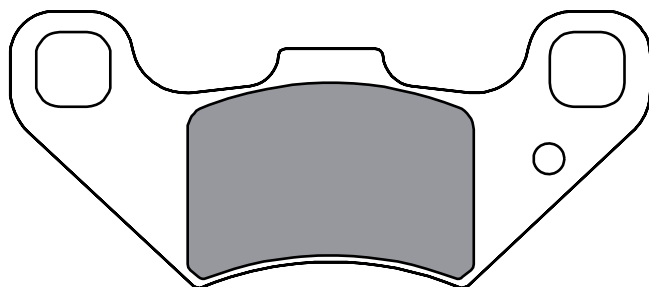

PGO

50	BUGRIDER	06	•
150	BR BUGXTER	05	•

200	BR BUGRIDER	07	•
250	BR BUGRIDER	05	•

QUADZILLA

250	E 250	06	•
250	XRV, E	06	•





07GR12.SA	76,9x	41,9x	7,5
07GR12.SP	"	"	"
07GR12.CC	"	"	"

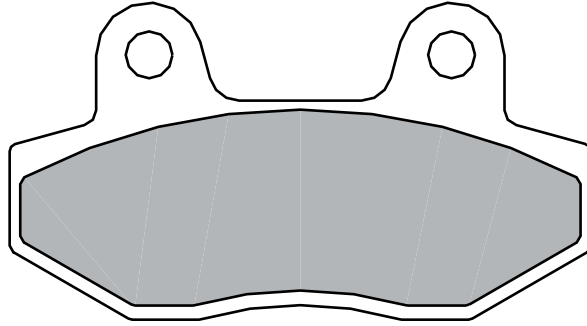

2

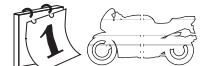
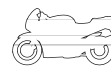
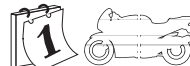
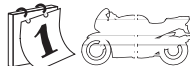
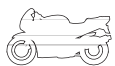

HYOSUNG

125	GT	07	•	•
125	GT COMET	04	•	•
125	GT R SUPERSPORT	07	•	•
125	GV AGUILA	05	•	
125	RT KARION	07	•	•
125	RX SM	07	•	•
125	XRX	07	•	•
250	GT COMET	03	•	•

250	GT R	07	•	•
650	GT	04	•	•
650	GT CUSTOM TRENDKILLER	07	•	•
650	GT R, GT S	05	•	•
650	GT TTC, GT X	07	•	•
650	GV AGUILA	06	•	•

125	TORPEDO	08	•	
150	TORPEDO	08	•	
650	BAZOOKA	06	•	•
650	GRIFON	06	•	•

ITALJET

50	ROLLERCRAFT	08	•	
----	-------------	----	---	--





07GR13.CC 78,9x 46,9x 7,3

2

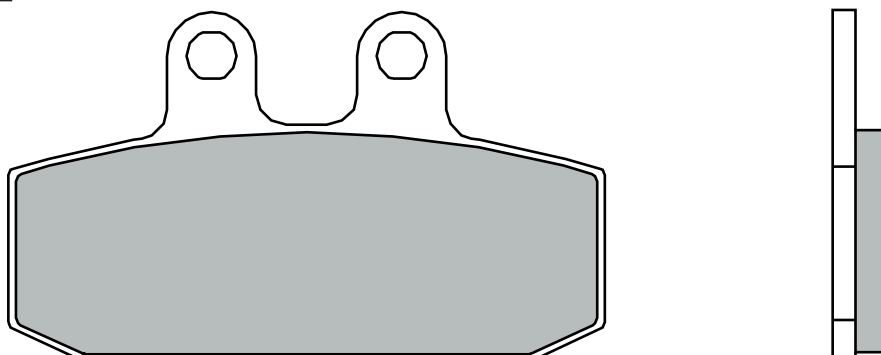

APRILIA

125 ETX	86 > 87	•
125 RED ROSE	89	•
600 ETX	86	•
850 MANA	08	•
850 MANA GT	09	•

CAGIVA

125 ROADSTER	94	•
200 ROADSTER	96	•

FANTIC MOTOR

250 RAIDER LC	84	•
---------------	----	---

GARELLI

125 TIGER XLE	86	•
---------------	----	---

GILERA

125 COUGAR	99	•
125 ER, NEBRASKA	86	•

125 FAST BIKE	88	•
125 KK, KR, KZ	85	•
125 MXR	90	•
125 R1	88	•
125 RTX	85	•
125 XR1, XR2	88	•
200 ARIZONA HAWK	85	•
200 ER	87	•
250 ARIZONA RALLY		•
350 DAKOTA	89	•
350 XRT	89	•
500 DAKOTA	86	•
600 XRT	89	•

HONDA

125 CA REBEL	97	•
125 CITYFLY	99	•
125 CRM, R	90 > 98	•
125 MTX CAMEL	88	•
125 MTX R	86	•
125 NS	85 > 88	•

125 NSR F	90 > 92	•
125 NSR R, ITALY	89	•
125 NX	90 > 98	•
125 RTV NSR	87	•
125 XL R, P.D.	85	•
200 XL R, P.D.	85	•

MALAGUTI

500 SPIDERMAX GT	04	•
500 SPIDERMAX RS 500	09	•

SACHS

125 ROADSTER	01	•
125 ZX	99	•
125 ZZ	99	•

SIMSON

125 RS	01	•
125 SCHIKRA	99	•





07GR14.06 76,5x 41,9x 7,3

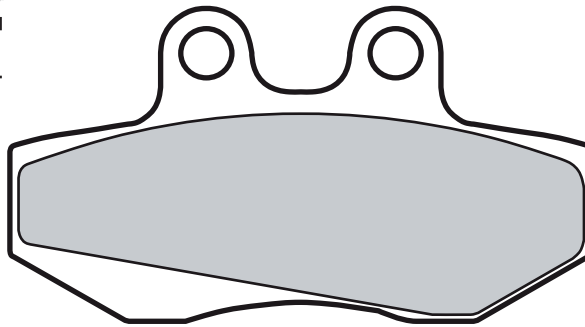

2

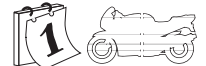
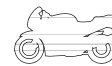
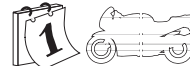
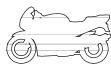
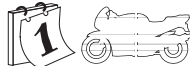
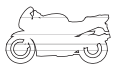

APRILIA

50	RX	08	•
125	CLASSIC	96	•
125	PEGASO	90 > 91	•
125	RED ROSE	90	•
125	TUAREG RALLY	92	•
125	TUAREG WIND	89	•
125	TUAREG WIND	90	•
600	PEGASO	90	•

BETA

50	PRO RACE	98	•
50	RR ENDURO	99	•
50	RR STANDARD	99	•
50	RR SUPERMOTARD	99 > 03	•

BULTACO

50	ASTRO	01	•
50	LOBITO	99	•

DERBI

50	GPR	98	•
50	SENDAR	03 > 04	•
125	ATMOSPHERE	99	•
180	PREDATOR	99	•

GAS GAS

50	EC ROOKIE	01 > 04	•
50	SM ROOKIE	01	•

GILERA

150	RUNNER FX	97	•
200	FX RUNNER	97 > 98	•

HRD

50	GS ENDURO	00	•
50	SONIC	00 > 02	•
50	SONIC TRIAL	00 > 02	•
125	SUPERMOTARD	00	•
125	TRIAL	00	•

HUSQVARNA

50	SM	02	•
50	WR	02	•

ITALJET

50	SM	02	•
125	SM	02	•

PEUGEOT

50	XR6	02 > 07	•
----	-----	---------	---

RIEJU

50	MRX PRO	05	•
50	RACING	01	•
50	RS2 MATRIX	03	• •
50	SMX	02	•
50	SPIKE	02	•
50	SPIKE (AJP caliper)	02	• •
125	MRX	03	•
125	SMX	03	•

SHERCO

50	SM, ENDURO	02	•
125	125	02	•
125	CITY CORP 4T ENDURO	03	• •
125	CITY CORP 4T SM	03	•

SIAMOTO

125	BD	02	•
-----	----	----	---

SIMSON

125	SM	01	•
-----	----	----	---

YAMAHA

125	XT X SUPERMOTARD	05	•
-----	------------------	----	---





07GR15.06 99,6x 46,9x 7,4

2

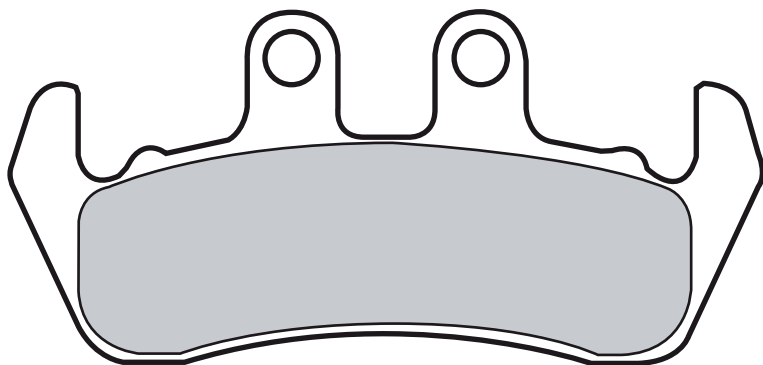

YAMAHA

125	DT TENERE SCOUT	90	•
125	DTZ TENERE	90	•



07GR17.05 55,4x 46,4x 6

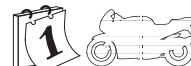
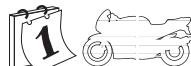
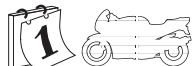
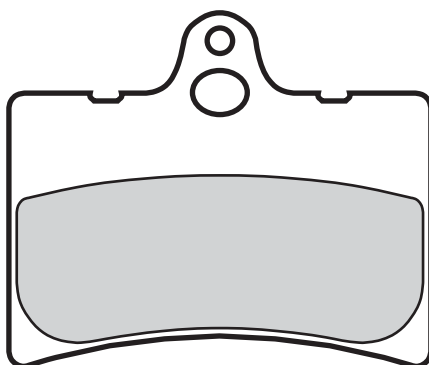

BENELLI

50	DEVIL	92	•
50	SPRING	92	•

BETA

TR 34	92	•
TR 36	92	•

CAGIVA

80	PRIMA	92	•
125	PRIMA	92	•





07GR21.06 87,1x 53x 7,4

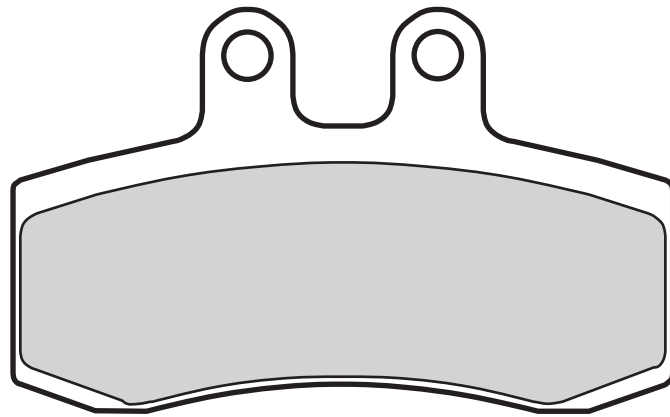

2

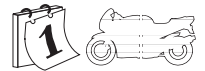
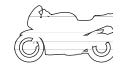
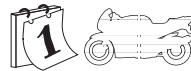
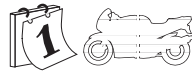

APRILIA

650 PEGASO 92 > 95 •

MZ

125 SM, SX 99 > 01 •

660 BAGHIRA MUZ 96 •

660 BLACK PANTHER MUZ 00 •

660 MASTIFF MUZ 00 •

660 STREET MOTO MUZ 00 •



07GR35.SP 69,4x 42,5x 7,5

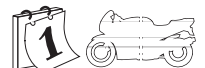
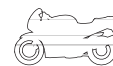
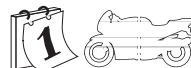
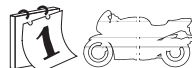
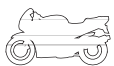
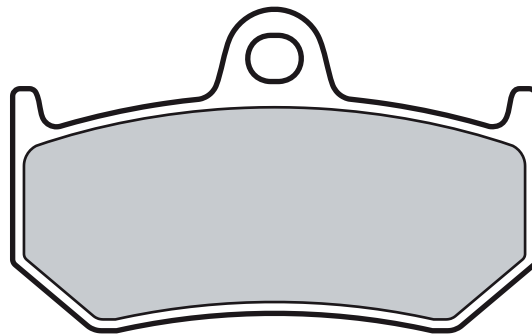

MV AGUSTA

750 BRUTALE 03 •

750 BRUTALE AMERICA 04 •

750 BRUTALE GLADIO 05 •

750 BRUTALE MAMBA 05 •

750 BRUTALE ORO 02 •

750 BRUTALE S 02 •

750 F4 00 > 04 •

750 F4 AGO 03 •

750 F4 SPR 03 •

910 BRUTALE R 06 •

910 BRUTALE S 04 •

989 BRUTALE R 08 •

1000 F4 CORSE 05 •

1000 F4 MAMBA 03 •

1000 F4 R 312 07 •

1000 F4 R, R 1+1 06 •

1000 F4 S, 1+1 04 •

1000 F4 SENNA 06 •

1000 F4 TAMBURINI 04 •

1078 BRUTALE 1078 RR 09 •

1078 BRUTALE RR 08 •

1078 F4 CC 08 •

1078 F4 RR 312 08 •





07GR48.04 35,6x 38,5x 6

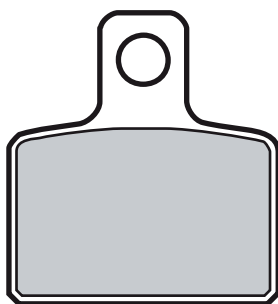

2



APRILIA

50 MINI RX 04 •

BETA

50 PRO RACE 04 • •

GAS GAS

125 TXT 04 •
200 TXT 04 •
250 TXT 04 •
280 TXT 04 •
300 TXT 04 •

HONDA

250 COTA 4 RT 05 •

HUSQVARNA

50 CR JUNIOR 06 •
50 CR PRO SENIOR 06 •
50 CR SENIOR 06 •

MONTESA

250 COTA 4RT 05 •
360 315R 01 > 04 •

SCORPA

115 SY F TRIAL 06 •
115 TY-S F TRIAL 06 •
125 SY F TRIAL 06 •
125 TY-S F TRIAL 06 •
250 SY F TRIAL 06 •

250 SY TRIAL 00 •

SHERCO

250 2.5 01 •
290 2.9 01 •
320 3.2 4T 05 •





07GR49.SD 62x 40,7x 9,5
82,2x40,7x 9,5

07GR49.SX " " "

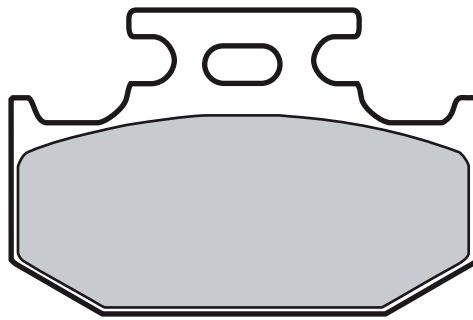

2

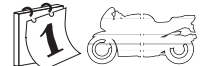
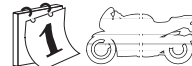
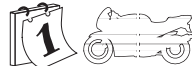
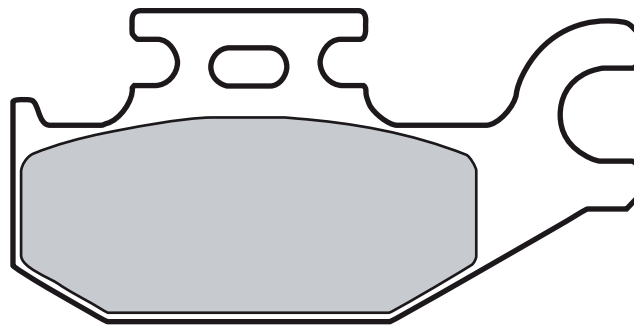

BOMBARDIER

250 DS Left/Rear	06	•	•
330 Outlander Left/Rear	03	•	•
400 Outlander Left/Rear	03 > 06	•	•
400 Outlander Left/Rear	07	•	
400 Outlander Max Left/Rear	03 > 06	•	•
400 Outlander Max Left/Rear	07	•	
500 Quest Left/Rear	02	•	•
500 Traxter 4x4 Left/Rear	01	•	•
500 Traxter Max Left/Rear	03 > 05	•	
650 DS Left/Rear (DS650/EBE)	01	•	•

650 Quest Left/Rear (Quest/EBE)	02	•	•
650 Quest Max Left/Rear	03	•	
650 Traxter Max Left/Rear	03 > 05	•	
800 Outlander Left/Rear	06	•	•
800 Outlander XT Left/Rear	06	•	•

CANNONDALE

440 Blaze Left/Rear	03	•	•
440 Cannibal Left/Rear	03	•	•
440 Glamis Left/Rear	03	•	•
440 Moto Left/Rear	03	•	•

440 Speed Left/Rear	03	•	•
---------------------	----	---	---

YAMAHA

400 XT	86	•	
400 YFM FAM Kodiak	00	•	
400 YFM FWN Big Bear 4WD	00	•	
400 YFM FWNH Big Bear-Buckmaster 4WD	00	•	
400 YFM N Big Bear 2WD	00	•	
450 YFM FA_ Kodiak	03	•	
450 YFM KODIAK	03	•	
450 YFM Wolverine	06	•	





07GR50.SD 62x 40,7x 9,5
82,2x40,7x 9,5

07GR50.SX " " "

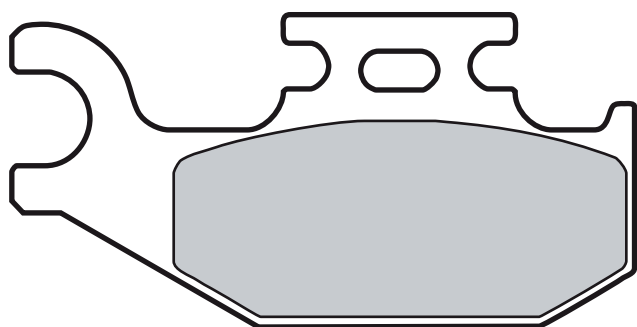
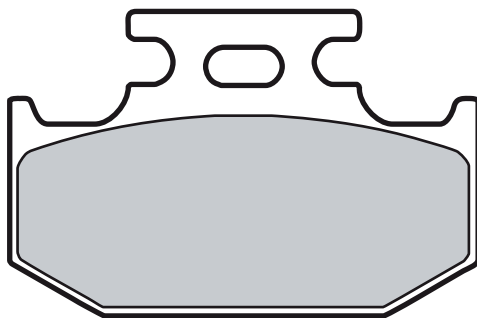

2



BOMBARDIER

250 DS Right	06	•
330 Outlander Right	03	•
400 Outlander Left/Rear	07	•
400 Outlander Max Left/Rear	07	•
400 Outlander Max Right	03	•
400 Outlander Right	03	•
500 Quest Right	02	•
500 Traxter 4x4 Right	01	•

500 Traxter Max Left/Rear	03 > 05	•
500 Traxter Max Right	03 > 05	•
650 DS Right (DS650/EBE)	01	•
650 Quest Max Left/Rear	03	•
650 Quest Max Right	03	•
650 Quest Right (Quest/EBE)	02	•
650 Traxter Max Left/Rear	03 > 05	•
650 Traxter Max Right	03 > 05	•
800 Outlander Right	06	•

800 Outlander XT Right	06	•
------------------------	----	---

CANNONDALE

440 Blaze Right	03	•
440 Cannibal Right	03	•
440 Glamis Right	03	•
440 Moto Right	03	•
440 Speed Right	03	•





07GR51.05 56,4x 43,5x 6,6

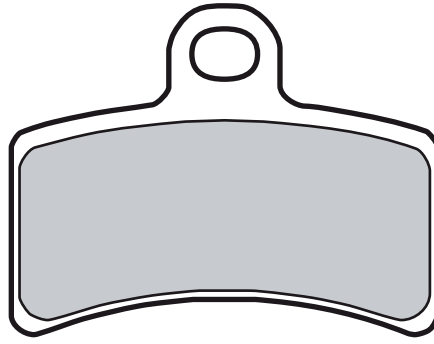

2

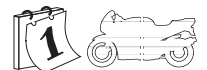
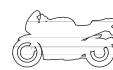
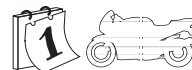
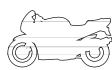
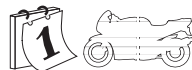

GAS GAS

50	EC BOY	01	•	•
50	EC ROOKIE	01 > 04	•	
50	SM ROOKIE	01	•	
50	TXT BOY	01 > 03	•	•

50	TXT ROOKIE	02 > 03	•	•
65	MC	05	•	•
80	TXT ROOKIE	02 > 03	•	•
125	PAMPERA	04	•	
250	PAMPERA	02	•	

280	PAMPERA	04	•	
-----	---------	----	---	--





07GR52.SD 94x 47x 8,7
73x 47x 10,7

07GR52.SX " " "

07GR52.09 " " "

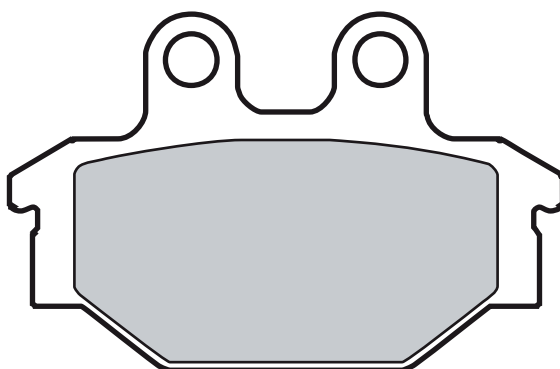
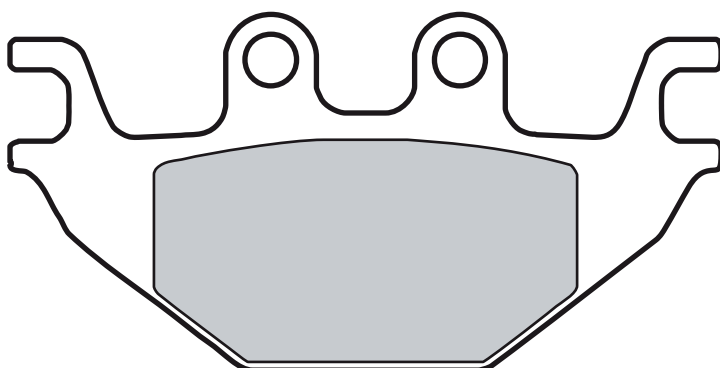

ADLY

300	ATV SPORT	07	•
300	CROSS X OVER	07	•
300	CROSS X ROAD	07	•
320	S	07	•
320	U	07	•

CPI

250	XS ATV	07	•
-----	--------	----	---

HERCULES

280	ATV	07	•
-----	-----	----	---

KYMCO

250	KXR	04	•
250	KXR (L3/e4/0235)	04	•
250	MXU	06	•
250	Urban Quad	06	•
300	MAXXER	06	•
300	MXU	06	• •
500	MXU	06	• •
500	UXV	08	• •

SYM

200	TRACKRUNNER	06	• •
250	QUADLANDER	06	•

300	CITY MAX	06	•
300	QUADLANDER	06	• •
600	QUAD RAIDER	08	• •

YAMAHA

125	YZF R	08	•
-----	-------	----	---





07GR53.SD 94,5x 45,5x 7

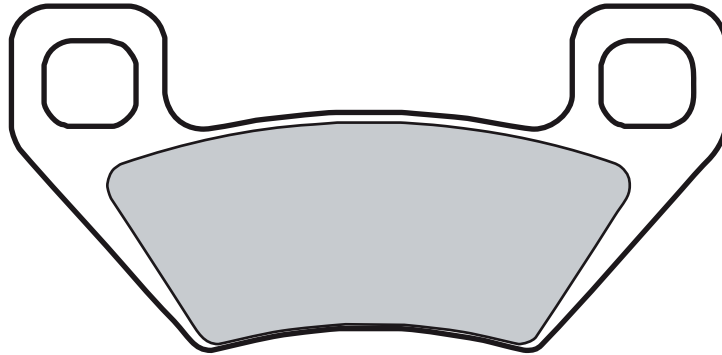

2

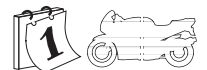
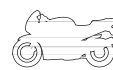
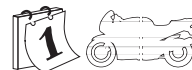
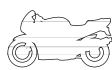
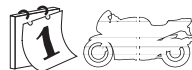

ARCTIC CAT

250	2x4	05	•	•
300	4x4	05	•	•
400	2x4/4x4 (FIS)	05	•	•
500	2x4/4x4 (FIS)	05	•	•

500	TBX 4x4	05	•	•
500	TRV 4x4	05	•	•
650	H1 4x4 Aut.	05	•	•
650	V2 4x4 Aut.	05	•	•
650	V2 4x4 Aut. LE	05	•	•

1000	THUNDERCAT	09	•	•
------	------------	----	---	---

KYMCO

400	MXU	08	•	•
-----	-----	----	---	---





07GR54.SD 67,6x 44x 7,7
07GR54.SX " " "

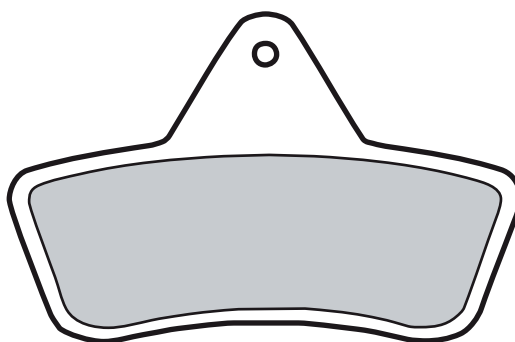

2

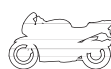
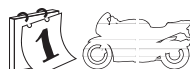
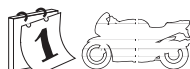
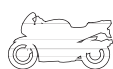

ARCTIC CAT

250	2x4/4x4	99 > 04	• •
300	2x4/4x4	98 > 04	• •
375	2x4/4x4	02	• •
400	2x4/4x4	98 > 04	• •
400	2x4/4x4 (FIS)	02 > 04	• •
400	TBX 4x4	04	• •
454	Arctic Cat 4x4	98	• •
454	Bear Cat 2x4/4x4	96 > 98	• •

500	2x4/4x4	98 > 04	• •
500	2x4/4x4 (FIS)	02 > 04	• •
500	TBX 4x4	02 > 04	• •
500	TRV 4x4	03 > 04	• •

500	QUASAR 4X4	04	• •
500	QUASAR 4X4 C	04	• •

LAVERDA

125	HP QUASAR	04	•
180	HP QUASAR	04	•
400	QUASAR 4X4	04	• •



07GR55.SD 43,2x 25,4x 8,4

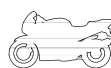
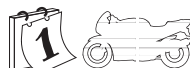
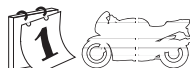

ARCTIC CAT

250	2x4 (Man. Hand Brake)	99	•
250	4x4 (Man. Hand Brake)	00	•
300	2x4 (Man. Hand Brake)	98 > 04	•
300	4x4 (Man. Hand Brake)	98	•
375	2x4/4x4 (Man. Hand Brake)	02	•
400	2x4 (Man. Hand Brake)	98 > 02	•

400	2x4/4x4 (FIS) Aut.(Man. Hand Brake)	03 > 04	•
400	2x4/4x4 (FIS)(Man. Hand Brake)	02 > 04	•
400	4x4 (Man. Hand Brake)	98 > 04	•
400	TBX 4x4 (Man. Hand Brake)	04	•
454	Bear Cat 2x4/4x4 (Man. Hand Brake)	98	•
500	2x4 (FIS)(Man. Hand Brake)	02	•
500	2x4 (Man. Hand Brake)	02	•

500	4x4 (FIS) Aut.(Man. Hand Brake)	02 > 03	•
500	4x4 (FIS)(Man. Hand Brake)	02 > 03	•
500	4x4 (Man. Hand Brake)	98 > 02	•
500	TBX 4x4 (Man. Hand Brake)	03 > 04	•
500	TBX 4x4 Aut.(Man. Hand Brake)	02	•
500	TRV 4x4 (Man. Hand Brake)	03 > 04	•





07GR56.SA	67,4x	50,9x	7
07GR56.SC	"	"	"
07GR56.05	"	"	"

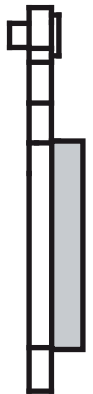
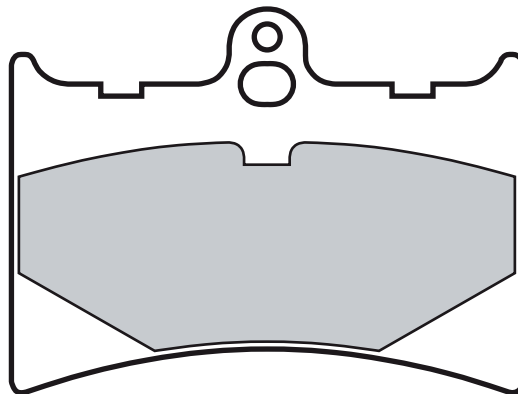

2

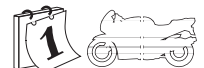
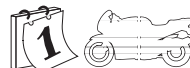
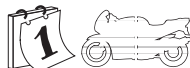

ALFER

125 MC	88	•
250 GR ENDURO	88	•
250 MC	88	•
300 GR ENDURO	88	•

APRILIA

125 AF1 FUTURA, EUROPA	89 > 91	•
125 AF1 REPLICA, SINTESI	88 > 89	•
125 RS	99 > 05	•
125 RS PISTA	04 > 05	•
125 RS, EXTREMA	93 > 98	•
125 SPORT PRODUCTION	92	•
125 TUONO	04	•

ASPES

125 SINTESI	88	•
-------------	----	---

BENELLI

125 BX	89	•
125 JARNO	89	•

GILERA

125 CHRONO	91	•
125 CX	91	•
125 FREESTYLE	92	•
125 MX1	88	•
125 SP 01, SP 02	89	•
600 NORDWEST	90	•

KTM

125 MX, GS	87	• •
250 GS	87	• •
250 MX	87	• •
500 MX	87	• •

600 MC, LC4, ENDURO	88	• •
---------------------	----	-----

MOTO GUZZI

1000 QUOTA	92 > 95	•
------------	---------	---

MZ

660 SKORPION SPORT MUZ	95 > 99	•
660 SKORPION TOUR MUZ	95 > 99	•
660 SKORPION TRAVELLER MUZ	99	•

TM

125 CROSS, ENDURO	89 > 90	•
125 CROSS, ENDURO	91	•





07GR57.05 75x 40,3x 6,7

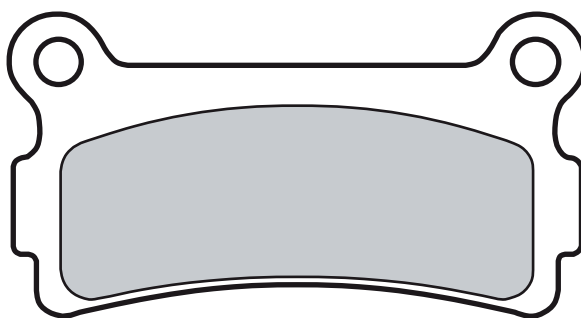

2



BETA

50	MX ENDURO	92	•
50	SUPER TRIAL	92	•
125	TRIAL	97	•
240	ALP	92 > 95	•

240	ALP	96	•
240	SUPER TRIAL	92	•
250	ALP	92 > 96	•
250	ZERO	91	•
260	SYNT	92	•

260	ZERO	91	•
	TR 34	92	•
	TR 36	92	•



07GR58.04 49,6x 43,4x 6

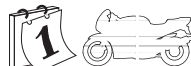
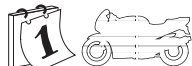
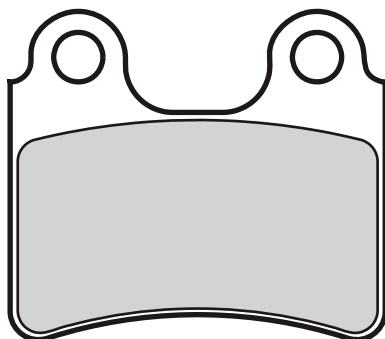

BETA

125	REV 3	00	• •
250	REV 3	00	• •
270	REV 3	00	• •

300	TXT	04	•
-----	-----	----	---

250	SY TRIAL	00	•
-----	----------	----	---

MONTESA

250	COTA 4RT	05	•
360	315R	01 > 04	•

SHERCO

250	2.5	01	•
290	2.9	01	•
320	3.2 4T	05	•

GAS GAS

50	EC ROOKIE	05	•
125	TXT	04	•
200	TXT	04	•
250	TXT	04	•
280	TXT	04	•

SCORPA

115	SY F TRIAL	06	•
125	SY F TRIAL	06	•
125	TY-S F TRIAL	06	•
250	SY F TRIAL	06	•





07GR59.15 71,6x 34,9x 9,4/13

2

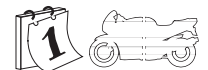
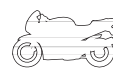
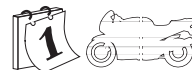
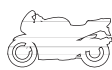
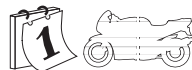
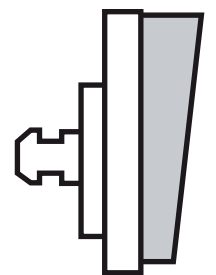
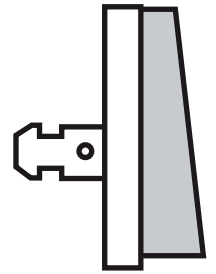
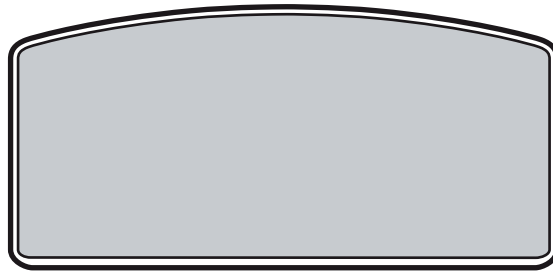

BMW

600 R 60/7	76 > 78 •
750 R 75/6	74 > 76 •
750 R 75/7	76 > 77 •
800 R 80/7	77 > 78 •

800 R 80/7	79 > 81 •
900 R 90 S	73 > 76 •
900 R 90/6	73 > 76 •
1000 R 100 RS	76 > 80 •
1000 R 100 RT	79 > 80 •

1000 R 100 S	76 > 77 •
1000 R 100 S	78 > 80 •
1000 R 100 T	79 •
1000 R 100/7	76 •





07GR60.07 55,6x 52,8x 9

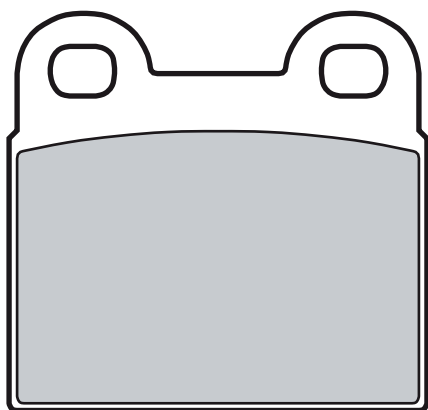

2

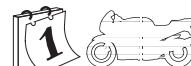

BMW

450 R 45	78 > 80	•
650 R 65	78 > 80	•

1000 R 100 CS	81 > 83	•
1000 R 100 RS	81 > 83	•
1000 R 100 RT	81 > 83	•



07GR62.SA 81x 45,9x 9
07GR62.SC " " "
07GR62.07 " " "

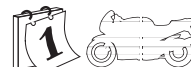
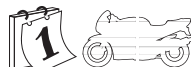
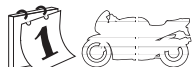
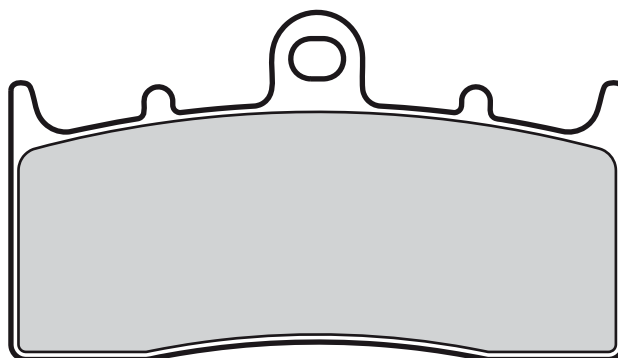

BMW

850 R 850 R	03	•
1100 R 1100 S ABS	01	•
1150 R 1150 R	01	•
1150 R 1150 R ROCKSTER	02	•

1150 R 1150 RS	01	•
1150 R 1150 S	03	•
1200 K 1200 LT ABS	01	•
1200 K 1200 R	07	•
1200 K 1200 R	05	•

1200 K 1200 R Sport	07	•
1200 R 1200 C	03	•
1200 R 1200 R	07	•
1300 K 1300 R	09	•





07GR63.19 44,5x43,2x 10
44,7x47,4x10,2

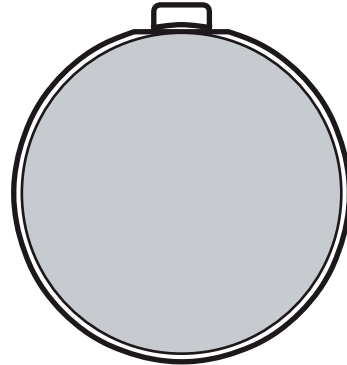
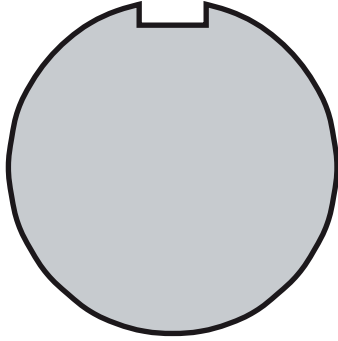

2

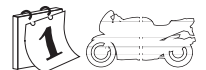
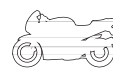
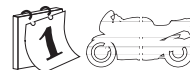
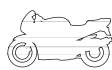
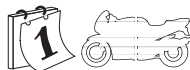

HYOSUNG

125 CRUISE II- CLASSIC	99	•
125 F	00	•
125 GA - GF	98	•
125 GS	99	•

SUZUKI

125 GP all models	77	•
-------------------	----	---





07GR64.TT 78,9x 45,9x 9

07GR64.07 " " "

2

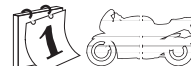
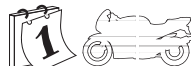
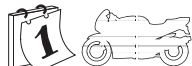
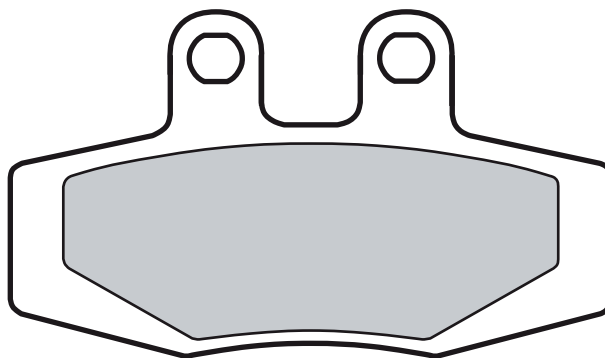

KTM

125	EXC	90 > 91	• •
125	GS	89 > 91	• •
125	MX, GS	88	• •
250	EXC	90 > 91	• •
250	GS	88 > 93	• •
250	MX	88	• •
300	EXC	90 > 92	• •
350	EXC	87	• •
350	EXC	88	• •
350	EXC	90 > 91	• •

350	GS	87	• •
350	GS	88	• •
350	MX	87	• •
350	MX	88	• •
500	MX	88	• •
550	LC4	87	• •
550	MX	87	• •
600	EXC	87	• •
600	EXC	88	• •
600	INCAS	89	• •
600	MX	87	• •

600	MX	88	• •
-----	----	----	-----

MAICO

250	GP	89	• •
400	GP	89	• •
500	GP	89	• •





07GR65.27 44,2/41,9x 44x 16
44,2/41,9x 44x 10

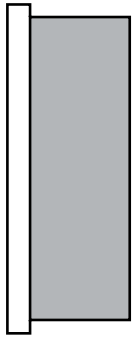
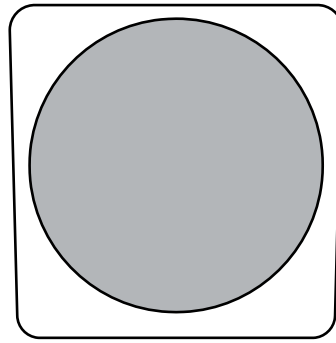

2

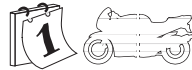
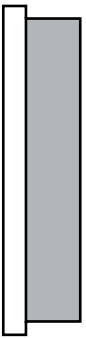
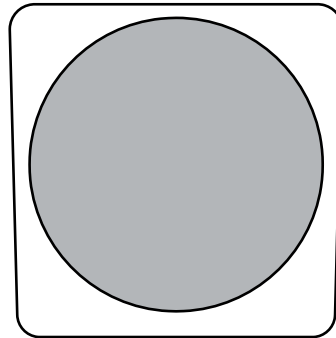

KAWASAKI

90	KH	78	•
100	KH EX,G	81 > 82	•
400	KZ	78 > 79	•



07GR66.10 59,5x 52x 10,4

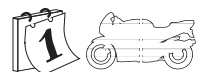
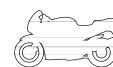
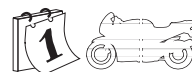
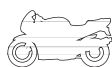
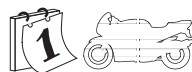
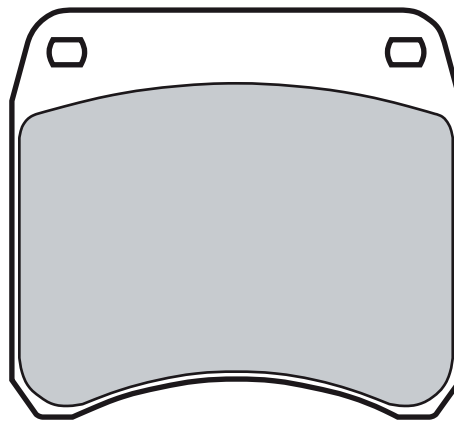

TRIUMPH

750	BONNEVILLE T 140 V, E	75 > 81	• •
750	BONNEVILLE T 140 V, E	81 > 83	• •
750	THUNDERBIRD TR 65	81	•
750	TIGER TR7 R TRIAL	81	•

750	TIGER TR7 V	73 > 81	• •
750	TRIDENT T 160 V	75 > 77	• •
750	TSS	82	• •
750	TSX	82	• •





07GR68.SA 91,6x 48,5x 7,9

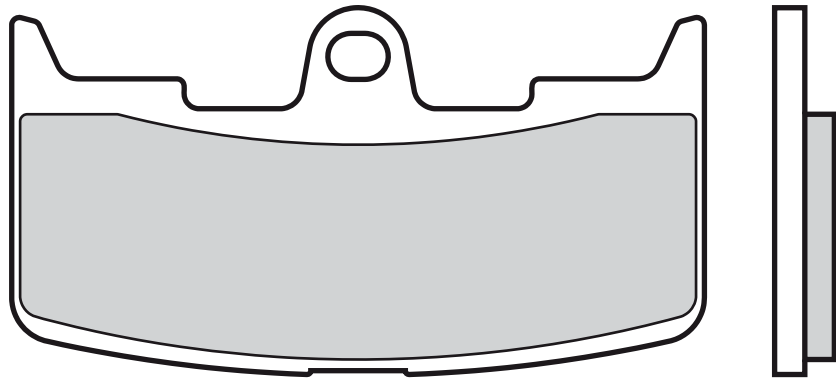

2

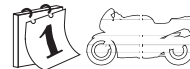
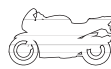
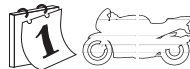
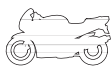
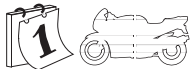

BUELL

984 XB 8 R	02	•
984 XB 8 S	03	•
984 XB 9 SX CITY X	05	•
1200 XB12 R	04	•

1200 XB12 S LIGHTNING	04 > 08	•
1200 XB12 STT SUPER TT	07	•
1200 XB12 X ULYSSES	06	•



07GR69.SD 61,8x 31,6x 6,5
07GR69.SX " " "

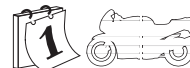
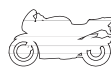
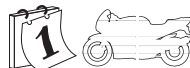
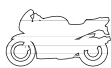
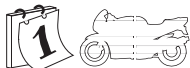
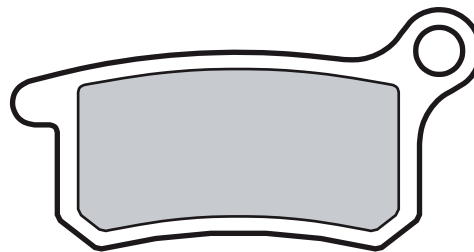
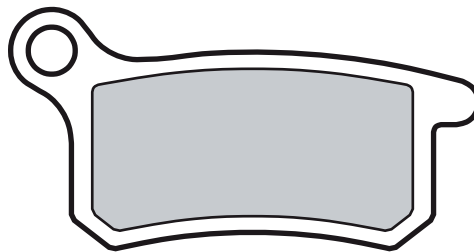

KTM

65 SX	09	• •
65 SX	02 > 03	•

65 SX	04 > 08	•
85 SX	04	• •





07GR70.SD 43,3x 25x 5
07GR70.SX " " "

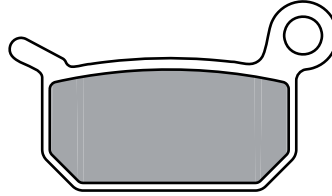
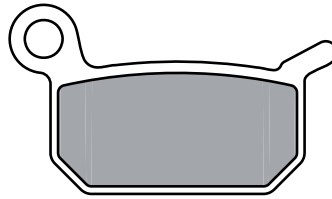

2

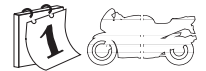
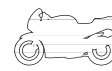
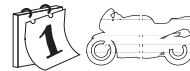
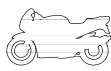
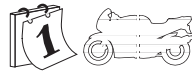

HUSQVARNA

50	CR PRO SENIOR	06	•
50	CR SENIOR	06	•

KTM

50	SM SUPERMOTO	06	• •
50	SX PRO JUNIOR	02	•

50	SX PRO SENIOR	02 > 03	•
50	SX PRO SENIOR	04	• •
50	SX PRO SENIOR ADVENTURE	04	•
65	SX	04 > 08	•

LEM

50	R2, R3, R3 XC	03	• •
----	---------------	----	-----

POLINI

50	X1 R	04	• •
50	X3 R	04	• •
65	X5 RP	05	• •



07GR71.SD 44,6x 50,7x 7
07GR71.SX " " "

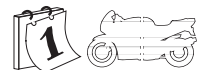
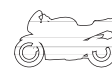
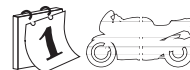
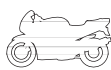
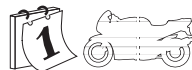
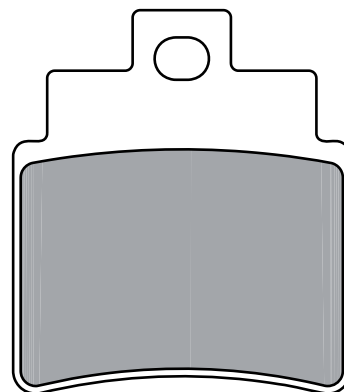

GILERA

250	Oregon Quad	07	•
-----	-------------	----	---

KYMCO

250	KXR	04	•
-----	-----	----	---

250	KXR (L3/e4/0235)	04	•
250	MXU	06	•
250	Urban Quad	06	•
300	MAXXER	06	•





07GR72.SA 69,7x 51,6x 7,5

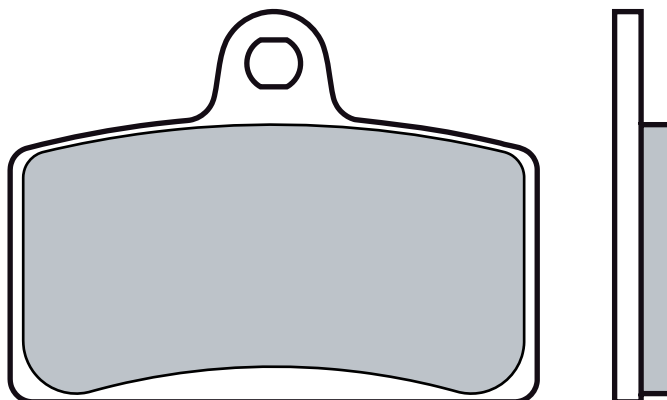

2

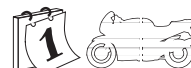
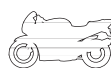
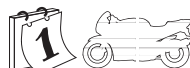
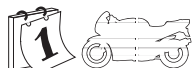

DERBI

50	DRD PRO R	06	•
50	GPX1	06	•
80	GPR CUP	04	•
125	GPR	05	•
125	GPR NUDE	05	•
125	GPR RACING	09	•

GILERA

125	SC	06	•
-----	----	----	---

MALAGUTI

50	DRAKON	05	•
50	NKD DRAGON	06	•

PEUGEOT

50	XR7	08	•
----	-----	----	---

RIEJU

125	TANGO	06 > 07	•
-----	-------	---------	---





07GR73.SD 62x 40,7x 8,3
82,2x40,7x 8,3

07GR73.SX " " "

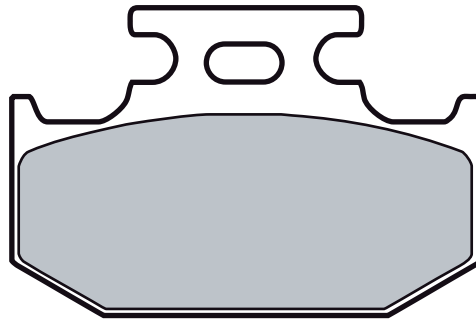

2

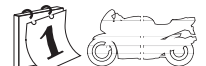
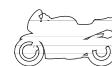
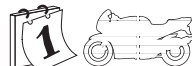
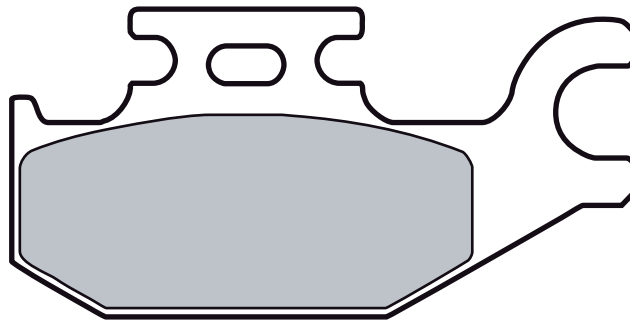

SUZUKI

400	KING QUAD KLT-A, KLT-F LEFT	08	•
400	KING QUAD LT-A, LT-F LEFT	08	•

450	KING QUAD LT-A LEFT	08	•
700	LT-A King Quad Left	05	•
750	KING QUAD LT-A LEFT	08	•





07GR74.SD 62x 40,7x 8,3
82,2x40,7x 8,3

07GR74.SX " " "

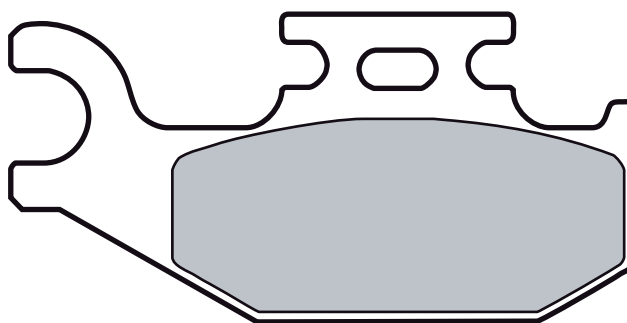
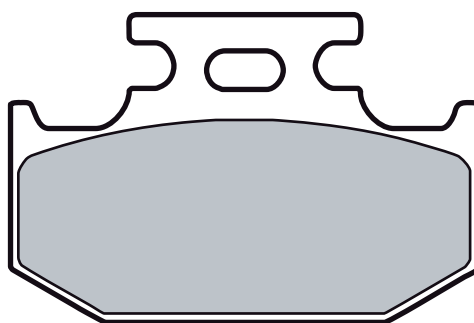

2

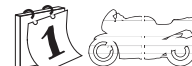
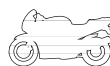
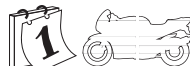
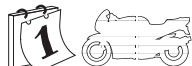

SUZUKI

400	KING QUAD KLT-A, KLT-F RIGHT	08	•
400	KING QUAD LT-A, LT-F RIGHT	08	•

450	KING QUAD LT-A RIGHT	08	•
700	LT-A King Quad Right	05	•
750	KING QUAD LT-A RIGHT	08	•

YAMAHA

450	YXR Rhino Left/Rear	06	•
700	YFM R Raptor Left	06	•





07GR75.SX 76,7x 49,7x 8,3

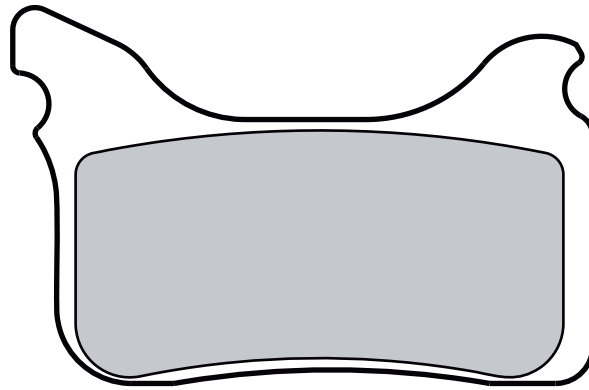

2

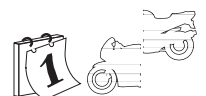
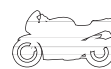
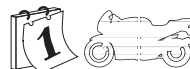
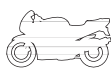
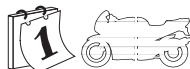
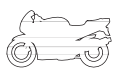
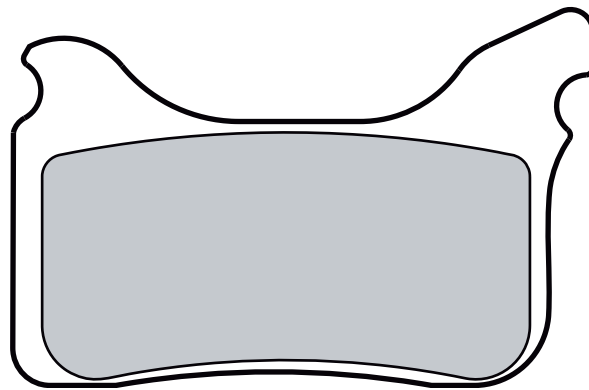

APRILIA

450 SXV	06	•
550 SXV	06	•
660 PEGASO STRADA FACTORY	05	•

KTM

450 SMR	04 > 06	•
525 SMR	05	•





07GR76.SA 34,9x 45,9x 7,7
07GR76.SX " " "
07GR76.RC " " "

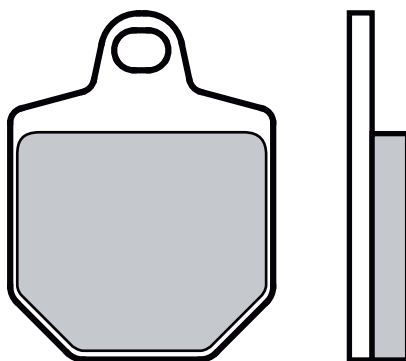

2

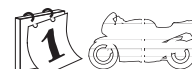
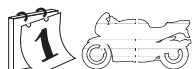
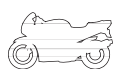

HM

125	CRM X SUPERMOTARD	07 > 07	•
250	CRM X SUPERMOTARD	07	•
450	CRM X SUPERMOTARD	07	•
500	CRM X SUPERMOTARD	07	•

KTM

450	SMR	07	•
560	SMR	06	•



07GR77.SA 68,3x 55,3x 9,2
07GR77.07 " " "

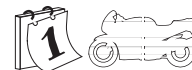
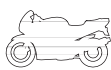
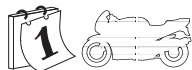
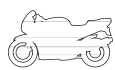
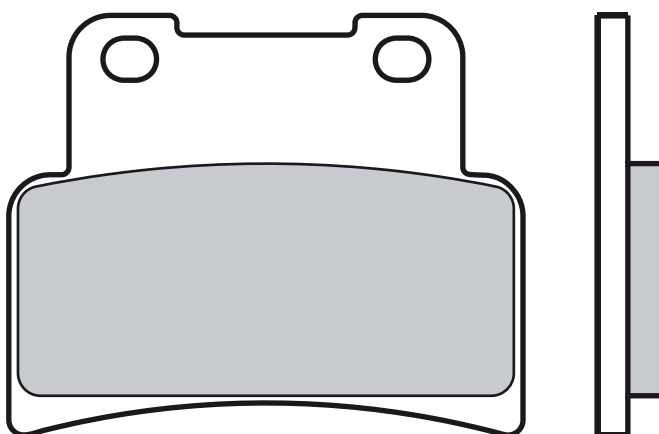

APRILIA

125	RS	06	•
125	RS	06	•
750	DORSODURO 750	09	•
750	DORSODURO 750 ABS	09	•

750	SHIVER	07	•
750	SHIVER 750	09	•
750	SHIVER 750 ABS	09	•
750	SHIVER 750 GT ABS	09	•
750	SHIVER 750 GT	09	•

850	MANA	07 > 07	•
850	MANA	08	•
850	MANA GT	09	•





07GR78.SD 103,5x42,4x9,1
62,5x 34,1x 11

07GR78.CC " " "

2

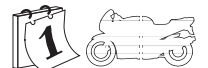
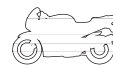
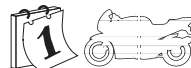
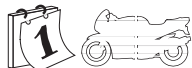
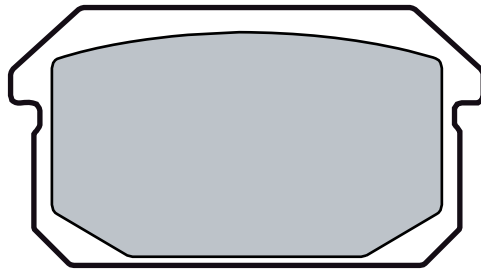
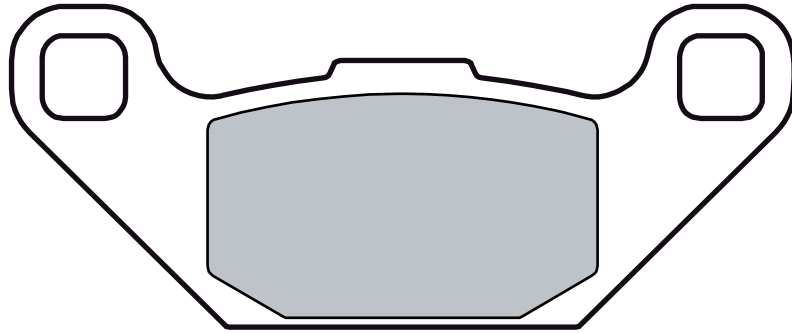

ADLY

300 ATV SPORT 07 •

CPI

250 XS Quad 06 •

QUADZILLA

250 E 250 06 •

250 XRV, E 06 •





07HD01.05 113,9x65,4x 7,2

2

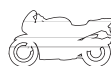
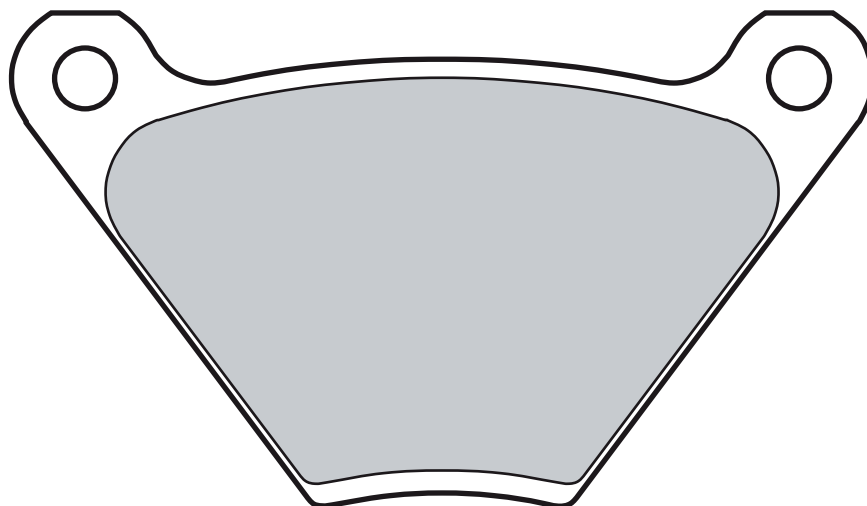

HARLEY DAVIDSON

1000 XLCH	73	•
1200 FL FLH POLICE	75 > 79	• •
1200 FLH	74 > 76	• •
1200 FLH	80	•
1200 FLH ANNIVERSARY	78	• •
1200 FLH TOURING	77 > 78	• •
1200 FLHS	77 > 80	• •
1200 FX	74 > 80	•

1200 FXE	74 > 80	•
1200 FXS	78 > 79	•
1340 FLH 80	78 > 80	• •
1340 FLH 80	81	•
1340 FLH ELECTRA GLIDE	82 > 83	•
1340 FLH ELECTRA GLIDE SPEC.	84	•
1340 FXB 80	80 > 81	•
1340 FXB STURGIS	82	•
1340 FXE 80	78 > 81	•

1340 FXE SUPER GLIDE	83 > 84	•
1340 FXEF 80 FAT BOB	79 > 81	•
1340 FXR	78 > 81	•
1340 FXS 80	79 > 81	•
1340 FXS LOW RIDER	82	•
1340 FXWG 80	80 > 81	•
1340 FXWG WIDE GLIDE	82	•
FXE SERIES	74 > 77	•





07HD02.02 53,4x 68,8x 6,5

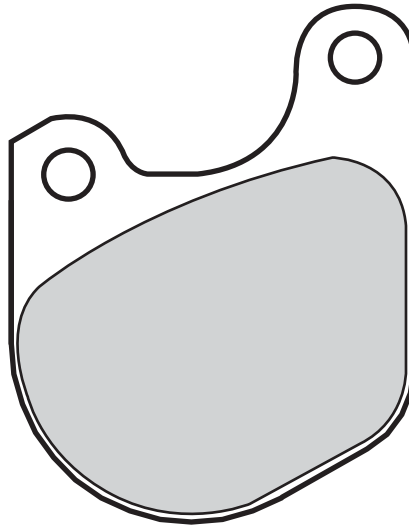

2

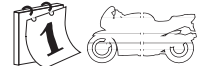
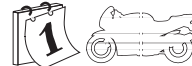
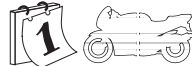

HARLEY DAVIDSON

883 XLH SPORTSTER	70 > 83	•
1000 XL	78	•
1000 XLCH	78 > 80	•
1000 XLH SPORTSER	79 > 82	•
1000 XLH SPORTSTER	83 > 85	•
1000 XLS ANNIVERSARY	82	•
1000 XLS ROADSTER	79 > 82	•
1000 XLS SPORTSTER	83	•
1000 XLX 61	83	•
1000 XLX 61	84	•
1000 XR	85	•
1200 FX	74 > 80	•

1200 FXE	74 > 80	•
1200 FXS	78 > 79	•
1340 FLTH TOUR GLIDE	84	•
1340 FXB 80	80 > 81	•
1340 FXB STURGIS	82	•
1340 FXE	82	•
1340 FXE 80	78 > 81	•
1340 FXE SUPER GLIDE	83 > 84	•
1340 FXEF 80 FAT BOB	79 > 81	•
1340 FXR	78 > 81	•
1340 FXR SUPER GLIDE	82 > 83	•
1340 FXRS LOW GLIDE	82 > 84	•
1340 FXRS SUPER GLIDE II	82 > 83	•

1340 FXRT SUPER GLIDE II	83	•
1340 FXS 80	79 > 81	•
1340 FXS LOW RIDER	82	•
1340 FXSB LOW RIDER	83	•
1340 FXWG 80	80 > 81	•
1340 FXWG WIDE GLIDE	82	•
1340 FXWG WIDE GLIDE	83	•
1340 FXWG WIDE GLIDE	84	•





07HD03.03 71,1x 88,9x 6,6

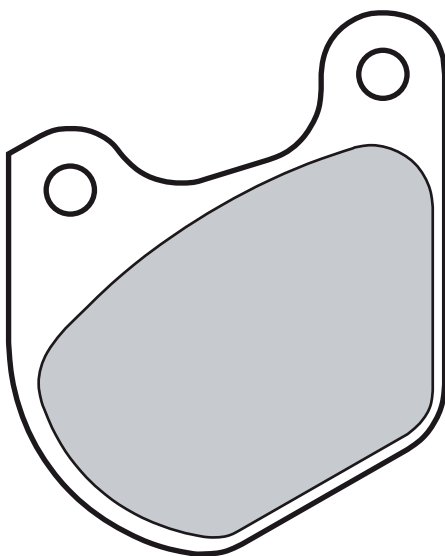

2

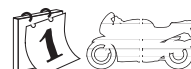
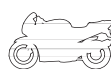
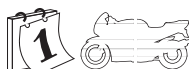
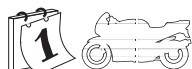
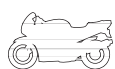

HARLEY DAVIDSON

1000 XL	78	•
1000 XLCH	78 > 80	•
1000 XLH SPORTSER	79 > 82	•
1000 XLS ROADSTER	79 > 82	•

1340 FLH CLASSIC	82 > 83	•
1340 FLH ELECTRA GLIDE	82 > 83	•
1340 FLH HERITAGE	81	•
1340 FLT 80	80 > 81	•
1340 FLT 80 CLASSIC	81	•

1340 FLT CLASSIC	82 > 83	•
1340 FLT TOUR GLIDE	82	•





07HD04.13 74,4x 48,9x 12

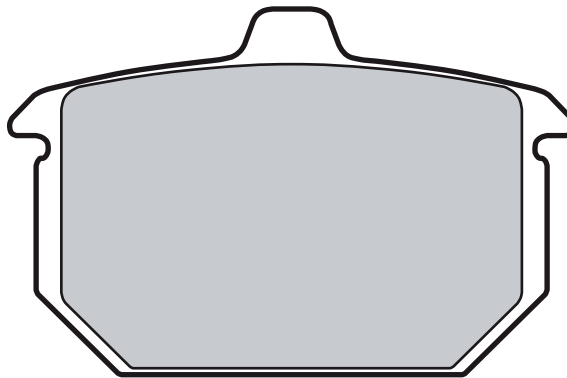

2

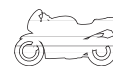
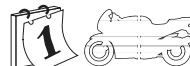
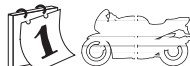

HARLEY DAVIDSON

883 XLH SPORTSTER	85 > 86	•
1000 XLH SPORTSTER	83 > 85	•
1000 XLS ANNIVERSARY	82	•
1000 XLS SPORTSTER	83	•
1000 XLX 61	83	•
1000 XLX 61	84	•
1000 XR	85	•
1100 XLH SPORTSTER	85 > 86	•
1100 XLX	86	•
1340 FLHT ELECTRA GLIDE	85 > 86	•

1340 FLHTC ELECTRA GLIDE CLASSIC	85 > 86	•
1340 FLST HERITAGE SOFTAIL	86 > 87	•
1340 FLTC TOUR GLIDE CLASSIC	85 > 86	•
1340 FXE	85 > 86	•
1340 FXR SUPER GLIDE	82 > 83	•
1340 FXR SUPER GLIDE	85 > 86	•
1340 FXRD SPORT GLIDE GTE	85 > 86	•
1340 FXRS LOW GLIDE	82 > 84	•
1340 FXRS LOW RIDER	85 > 86	•
1340 FXRS SUPER GLIDE II	82 > 83	•
1340 FXRT SPORT GLIDE	85 > 86	•

1340 FXRT SUPER GLIDE II	83	•
1340 FXSB LOW RIDER	83	•
1340 FXST SOFTAIL	84 > 86	•
1340 FXSTC SOFTAIL CUSTOM	85 > 86	•
1340 FXWG WIDE GLIDE	83	•
1340 FXWG WIDE GLIDE	84	•
1340 FXWG WIDE GLIDE	85 > 86	•





07HD05.07 174,3x72,8x 10,4

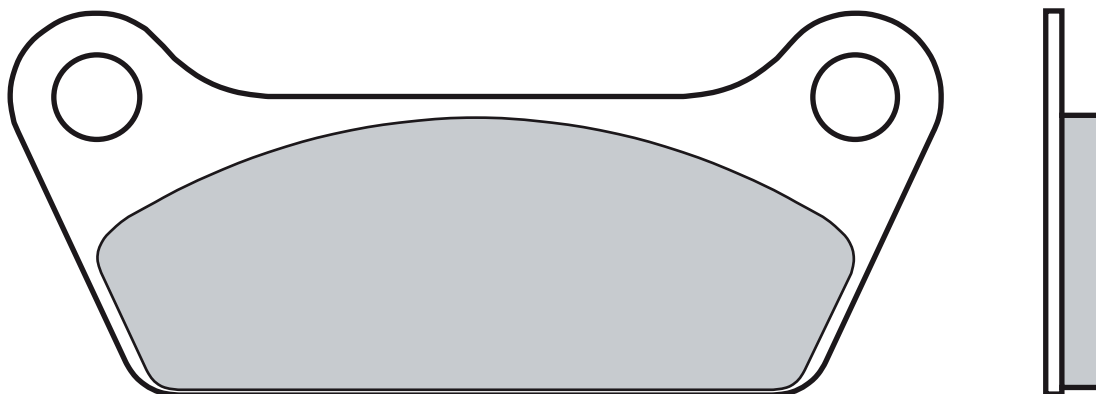

2

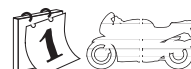
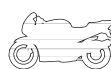
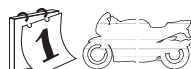
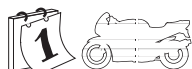
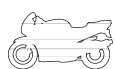

HARLEY DAVIDSON

1200 FLH	80	•
1340 FLH 80	81	•
1340 FLH CLASSIC	82 > 83	•
1340 FLH ELECTRA GLIDE SPEC.	84	•

1340 FLH HERITAGE	81	•
1340 FLT	84 > 85	•
1340 FLT 80	80 > 81	•
1340 FLT 80 CLASSIC	81	•
1340 FLT CLASSIC	82 > 83	•

1340 FLT TOUR GLIDE	82	•
1340 FLTH TOUR GLIDE	84	•





07HD06.14 59,3x 61,5x 13

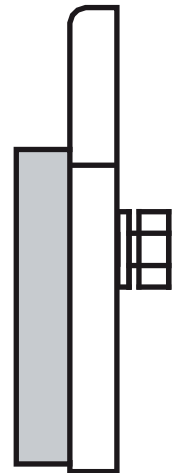
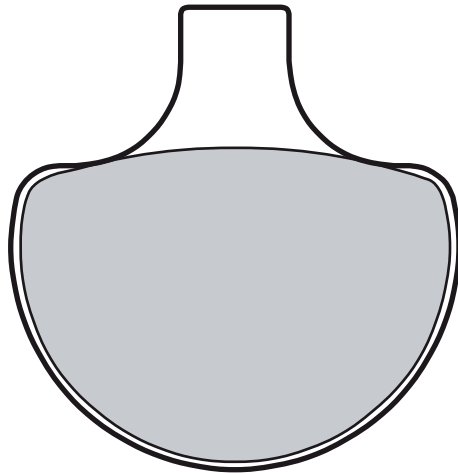

2

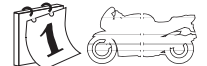
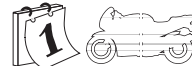
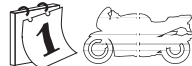
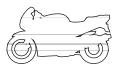

HARLEY DAVIDSON

883	XLH SPORTSTER	85 > 86	•
883	XLH SPORTSTER	87 > 89	•
883	XLH SPORTSTER	90 > 99	•
1100	XLH	87 > 88	•
1100	XLH SPORTSTER	85 > 86	•
1100	XLX	86	•
1200	XLH SPORTSTER	90 > 99	•
1340	FLHS ELECTRA GLIDE SPORT	90	•
1340	FLHT ELECTRA GLIDE	85 > 86	•
1340	FLHT ELECTRA GLIDE CLASSIC	87 > 99	•
1340	FLHTC ELECTRA GLIDE CLASSIC	85 > 86	•
1340	FLHTC ELECTRA GLIDE CLASSIC	90 > 99	•
1340	FLHTC ELECTRA GLIDE CLASSIC	93	•
1340	FLHTC ULTRA CLASSIC	90 > 99	•
1340	FLST HERITAGE SOFTAIL	86 > 87	•
1340	FLST HERITAGE SOFTAIL	88 > 99	•
1340	FLSTC HERITAGE SOFTAIL CL.	90 > 99	•
1340	FLSTF FAT BOY	90 > 99	•

1340	FLSTN HERITAGE SOFTAIL NOST.	93 > 99	•
1340	FLT	84 > 85	•
1340	FLTC TOUR GLIDE CLASSIC	85 > 86	•
1340	FLTC TOUR GLIDE CLASSIC	90	•
1340	FXDB DYNA GLIDE DAYTONA	91 > 99	•
1340	FXDB DYNA GLIDE STURGIS	91 > 99	•
1340	FXDB STURGIS	91 > 99	•
1340	FXDL Dyna Low Rider	93 > 99	•
1340	FXDWGDYNA WIDE GLIDE	93 > 99	•
1340	FXE	85 > 86	•
1340	FXLR LOW RIDER CUSTOM	93 > 99	•
1340	FXLR LOW RIDER CUSTOM	87 > 88	•
1340	FXR	87 > 88	•
1340	FXR SUPER GLIDE	90 > 99	•
1340	FXR SUPER GLIDE	85 > 86	•
1340	FXRD SPORT GLIDE GTE	85 > 86	•
1340	FXRS LLOW RIDER SPORT ED.	90 > 99	•
1340	FXRS LOW RIDER	85 > 86	•
1340	FXRS LOW RIDER SPORT	87 > 99	•

1340	FXRS LOW RIDER, CONVERT.	90 > 99	•
1340	FXRT SPORT GLIDE	85 > 86	•
1340	FXRT SPORT GLIDE	90 > 99	•
1340	FXST SOFTAIL	84 > 86	•
1340	FXSTC SOFTAIL CUSTOM	85 > 86	•
1340	FXSTC SOFTAIL CUSTOM	88 > 99	•
1340	FXSTS SPRINGER SOFTAIL	90 > 99	•
1340	FXWG	87 > 88	•
1340	FXWG WIDE GLIDE	85 > 86	•
1450	FLSTS/I HERITAGE SPRINGER	00 > 03	•
1450	FLSTSC/I SPRINGER SOFTAIL CLASSIC	05 > 06	•
1450	FLSTSC/I SPRINGER SOFTAIL CLASSIC	07	•
1450	FXSTS/I SPRINGER SOFTAIL	00 > 04	•
1450	FXSTS/I SPRINGER SOFTAIL	05 > 06	•
1450	FXSTS/I SPRINGER SOFTAIL	07	•
	FLT SERIES	88 > 99	•
	FLT/H SERIES	86 > 87	•
	XLH SERIES	88 > 99	•





07HD07.SP 127,1x50,8x7,4

2

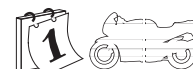
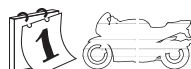
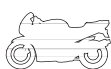
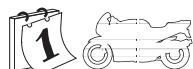
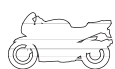
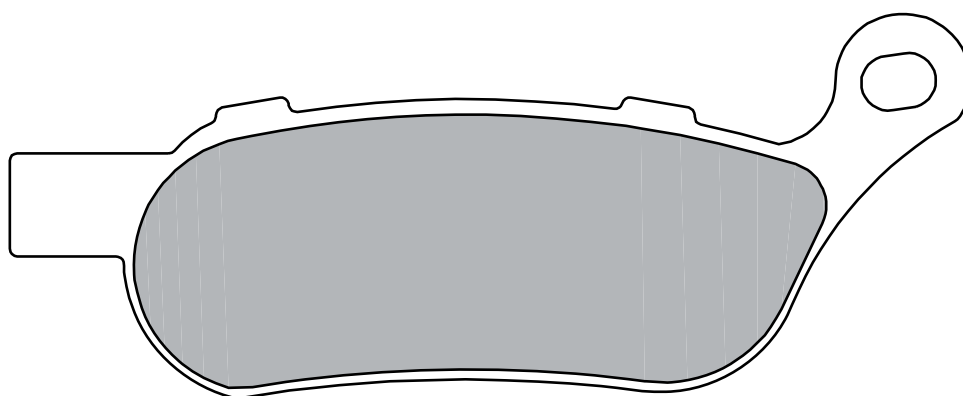
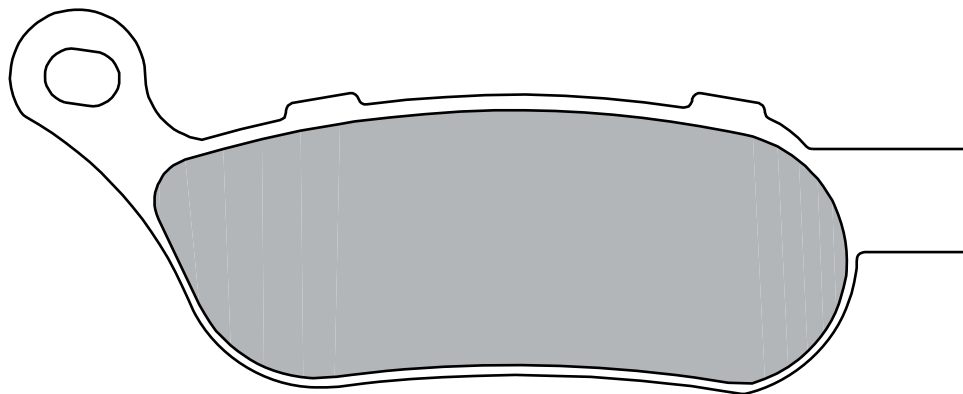

HARLEY DAVIDSON

1584	FLSTC/HERITAGE SOFTAIL CLASSIC	08	•
1584	FLSTF/FAT BOY	08	•
1584	FLSTN/SOFTAIL DELUXE	08	•
1584	FXCW/ROCKER	08	•

1584	FXCWC/ROCKER C	08	•
1584	FXD/DYNA SUPER GLIDE	08	•
1584	FXDB/DYNA STREET BOB	08	•
1584	FXDC/DYNA SUPER GLIDE CUSTOM	08	•
1584	FXDF/FAT BOB	08	•

1584	FXDL/DYNA LOW RIDER	08	•
1584	FXDWG/DYNA WIDE GLIDE	08	•
1584	FXST/SOFTAIL STANDARD	08	•
1584	FXSTB/NIGHT TRAIN	08	•
1584	FXSTC/SOFTAIL CUSTOM	08	•





07HD08.SP 46x 49,5x 7

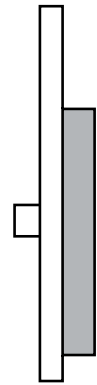
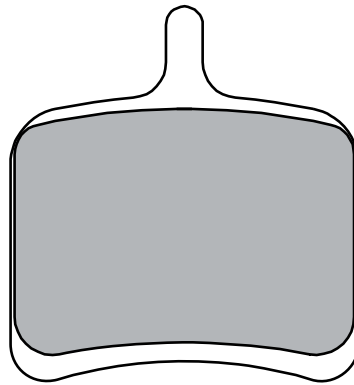

2

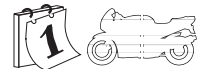
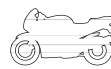
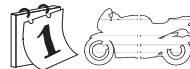
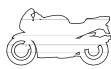
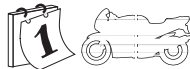
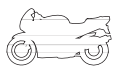

BUELL

1125 CR	09	•
1125 R	08	•



07HD09.10 104,1x 62x 11,5

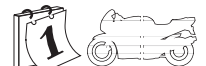
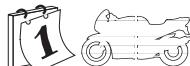
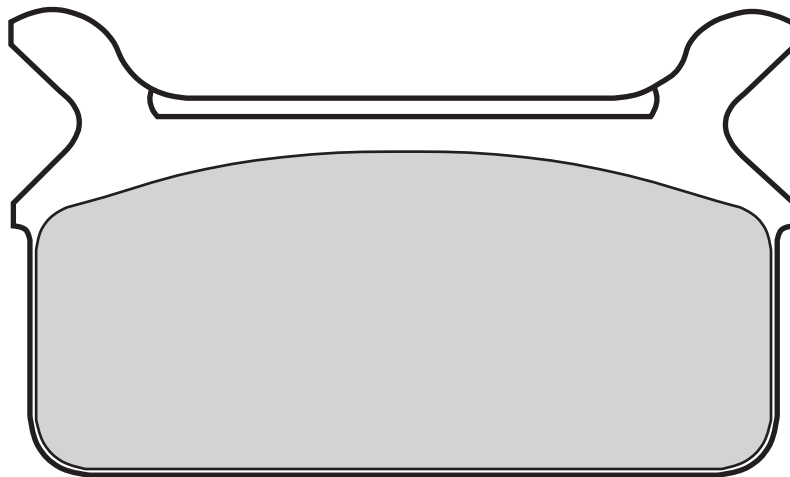

HARLEY DAVIDSON

1340 FLHS ELECTRA GLIDE SPORT	90	•
1340 FLHTC ELECTRA GLIDE CLASSIC	90 > 99	•

1340 FLHTC ULTRA CLASSIC	90 > 99	•
1340 FLST HERITAGE SOFTAIL	88 > 99	•
1340 FLTC TOUR GLIDE CLASSIC	90	•

FLT SERIES	88 > 99	•
FLT/H SERIES	86 > 87	•





07HD10.11 104,1x62x 11,3

2

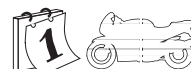
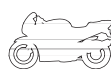
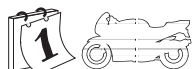
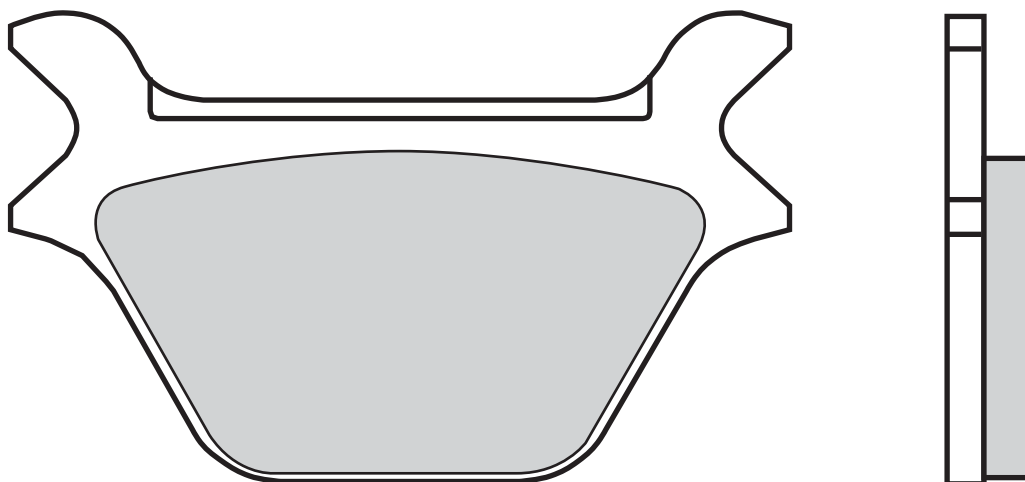

HARLEY DAVIDSON

883	XLH SPORTSTER	87 > 89	•
883	XLH SPORTSTER	90 > 99	•
1100	XLH	87 > 88	•
1200	XLH SPORTSTER	90 > 99	•
1340	FLHT ELECTRA GLIDE CLASSIC	87 > 99	•
1340	FLHTC ELECTRA GLIDE CLASSIC	93	•
1340	FLSTC HERITAGE SOFTAIL CL.	90 > 99	•
1340	FLSTF FAT BOY	90 > 99	•
1340	FLSTN HERITAGE SOFTAIL NOST.	93 > 99	•
1340	FXDB DYNA GLIDE DAYTONA	91 > 99	•

1340	FXDB DYNA GLIDE STURGIS	91 > 99	•
1340	FXDB STURGIS	91 > 99	•
1340	FXDL Dyna Low Rider	93 > 99	•
1340	FXDWGDYNA WIDE GLIDE	93 > 99	•
1340	FXE	82	•
1340	FXLR LOW RIDER CUSTOM	93 > 99	•
1340	FXLR LOW RIDER CUSTOM	87 > 88	•
1340	FXR	87 > 88	•
1340	FXR SUPER GLIDE	90 > 99	•
1340	FXRS LLOW RIDER SPORT ED.	90 > 99	•
1340	FXRS LOW RIDER SPORT	87 > 99	•

1340	FXRS LOW RIDER, CONVERT.	90 > 99	•
1340	FXRT SPORT GLIDE	90 > 99	•
1340	FXSTC SOFTAIL CUSTOM	88 > 99	•
1340	FXSTS SPRINGER SOFTAIL	90 > 99	•
1340	FXWG	87 > 88	•
	XLH SERIES	88 > 99	•





07HD11.09 111,9x56,2x 10,9

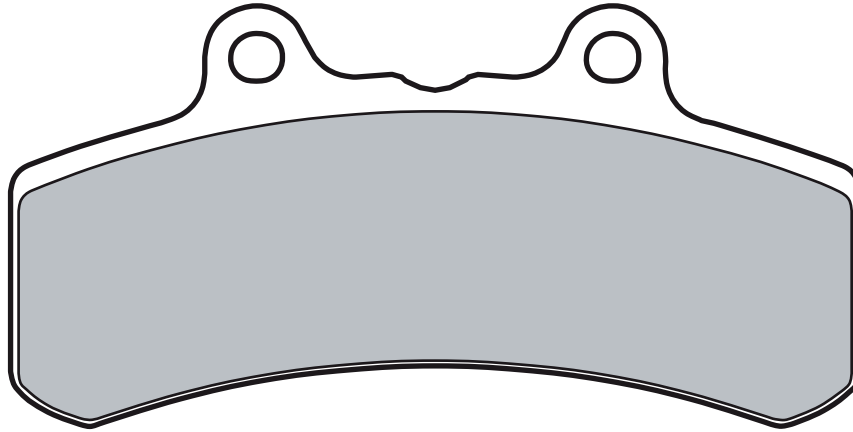

2

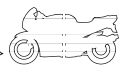
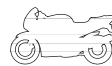
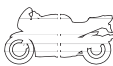

BUELL

1200 M2	97	•
1200 RS	93	•





07HD13.SA101,6x38,6x 8,9

2

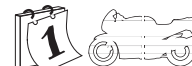
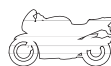
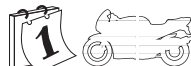
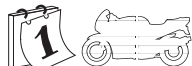
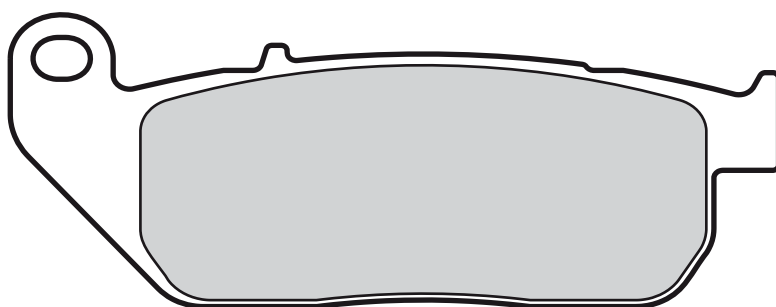
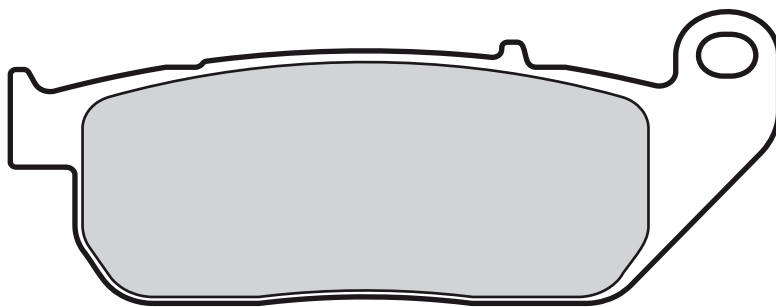

HARLEY DAVIDSON

883	XL C SPORTSTER CUSTOM	04	•
883	XL L SPORTSTER LOW	06	•

883	XL SPORTSTER	04	•
1200	XL C SPORTSTER CUSTOM	04	•
1200	XL N NIGHTSTER	07	•

1200	XL R SPORTSTER ROADSTER	04	•
------	-------------------------	----	---





07HD14.SP 85,7x 44,3x 10

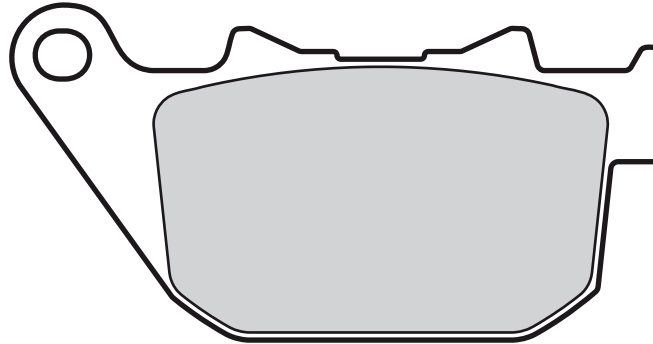

2

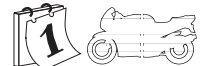
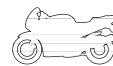
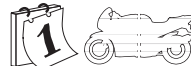
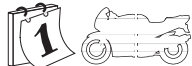
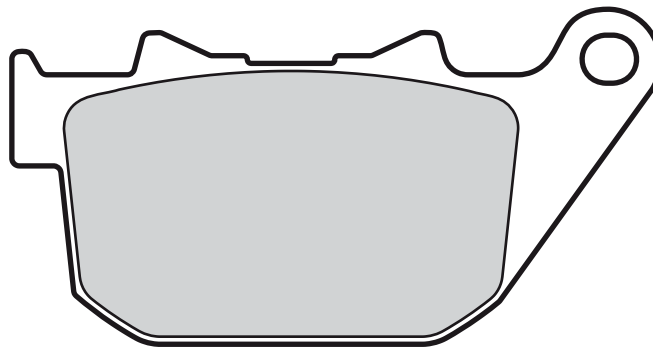

HARLEY DAVIDSON

883	XL C SPORTSTER CUSTOM	04	•
883	XL L SPORTSTER LOW	06	•

883	XL SPORTSTER	04	•
1200	XL C SPORTSTER CUSTOM	04	•
1200	XL N NIGHTSTER	07	•

1200	XL R SPORTSTER ROADSTER	04	•
1200	XR	08	•





07HD15.SA 88,6x 61,8x 8

2

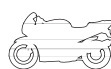
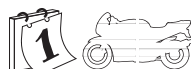
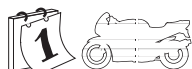
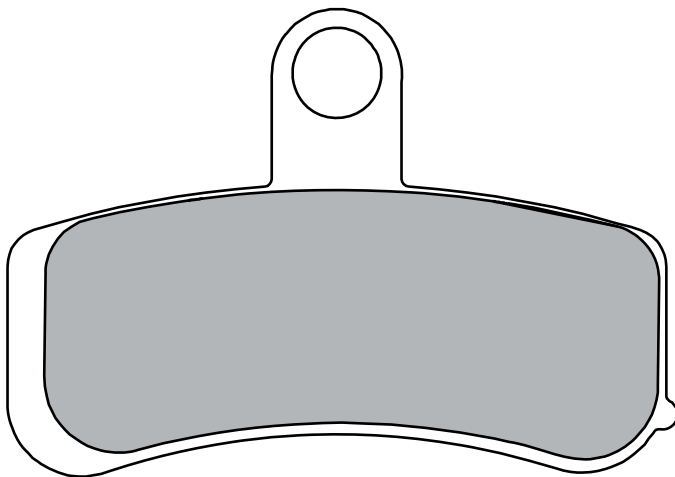
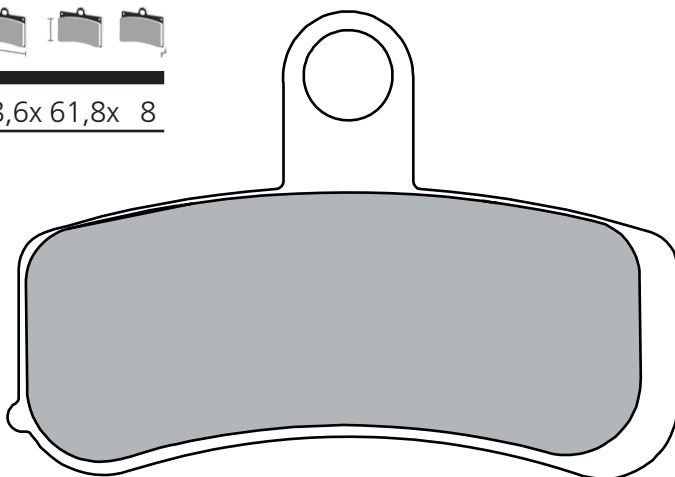

HARLEY DAVIDSON

1584	FLSTC/HERITAGE SOFTAIL CLASSIC	08	•
1584	FLSTF/FAT BOY	08	•
1584	FLSTN/SOFTAIL DELUXE	08	•
1584	FXCW/ROCKER	08	•

1584	FXCWC/ROCKER C	08	•
1584	FXD/DYNA SUPER GLIDE	08	•
1584	FXDB/DYNA STREET BOB	08	•
1584	FXDC/DYNA SUPER GLIDE CUSTOM	08	•
1584	FXDF/FAT BOB	08	•

1584	FXDL/DYNA LOW RIDER	08	•
1584	FXDWG/DYNA WIDE GLIDE	08	•
1584	FXST/SOFTAIL STANDARD	08	•
1584	FXSTB/NIGHT TRAIN	08	•
1584	FXSTC/SOFTAIL CUSTOM	08	•





07HD16.SA 97,3x 63,4x 8

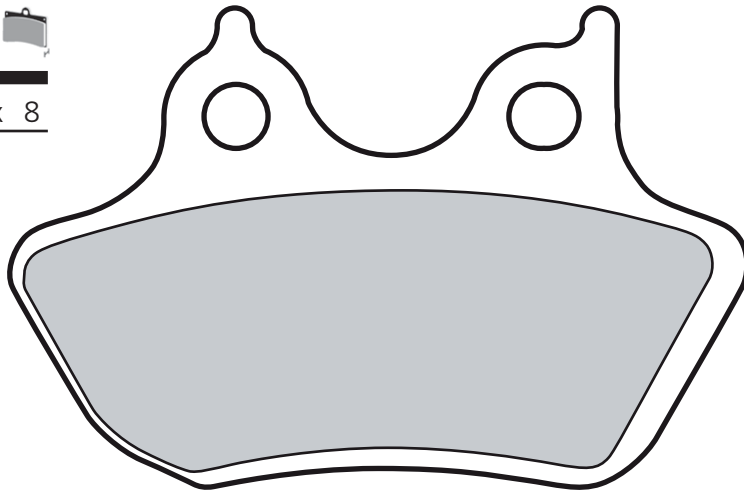

2

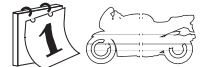
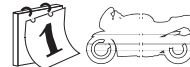
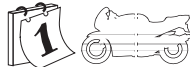
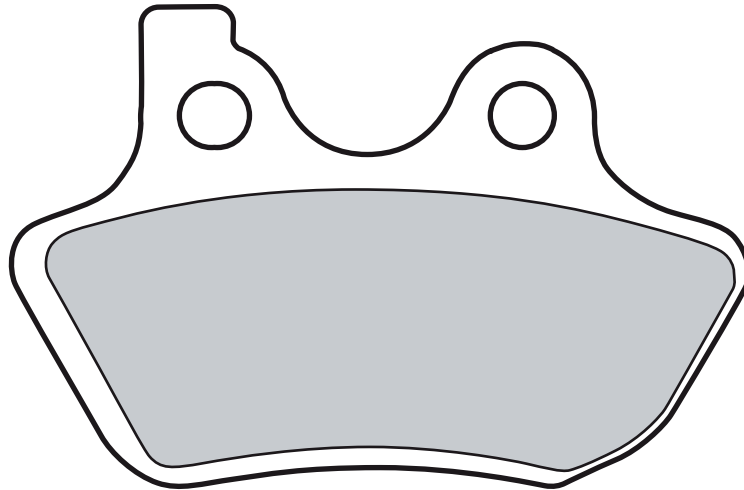

HARLEY DAVIDSON

883	XL R SPORTSER	00 > 03	•	1450	FLHRS/I ROAD KING CUSTOM	05	•	1450	FLTR/I ROAD GLIDE CLASSIC	00 > 04	•
883	XL Sportster Custom	00 > 03	•	1450	FLHT/I EL. GLIDE STANDARD	00 > 04	• •	1450	FLTR/I ROAD GLIDE CLASSIC	05	•
883	XLH SPORTSTER	00 > 03	• •	1450	FLHT/I EL. GLIDE STANDARD	05	•	1450	FXD DYNA SUPER GLIDE	00 > 03	•
883	XLH SPORTSTER HUGGER	00 > 03	•	1450	FLHTC/I EL. GLIDE CLASSIC	00 > 04	•	1450	FXDBIDYNA STREET BOB	06	•
1130	VRSCA V-ROD	02	• •	1450	FLHTC/I EL. GLIDE CLASSIC	05	•	1450	FXDCI DYNA SUPER GLIDE CUSTOM	05	• •
1130	VRSCB V-ROD	04	•	1450	FLHTCUI ULTRA CLASSIC EL. GLIDE	00 > 04	•	1450	FXDI 35th ANN. SUPER GLIDE	06	•
1200	XL SPORTSTER CUSTOM	00 > 03	•	1450	FLHTCUI ULTRA CLASSIC EL. GLIDE	05	•	1450	FXDI DUNA SUPER GLIDE	04	•
1200	XL SPORTSTER SPORT	00 > 03	•	1450	FLHXI STREET GLIDE	06	• •	1450	FXDI DUYNIA SUPER GLIDE	05	• •
1200	XLH SPORTSTER	00 > 03	•	1450	FLSTC/I HR. SOFTAIL CLASSIC	00 > 04	•	1450	FXDL DYNA LOW RIDER	00 > 03	•
1450	FLHR/I ROAD KING	00 > 04	•	1450	FLSTC/I HR. SOFTAIL CLASSIC	05 > 06	•	1450	FXDLI DYNA LOW RIDER	04	•
1450	FLHR/I ROAD KING	05	•	1450	FLSTC/I HR. SOFTAIL CLASSIC	07	•	1450	FXDLI DYNA LOW RIDER	05	•
1450	FLHRCI ROAD KING CLASSIC	00 > 04	•	1450	FLSTF/I FAT BOY	00 > 04	• •	1450	FXDS DYNA CONVERTIBLE	00 > 02	• •
1450	FLHRCI ROAD KING CLASSIC	05	• •	1450	FLSTF/I FAT BOY	05	•	1450	FXDWG DYNA WIDE GLIDE	00 > 03	•
1450	FLHRS/I ROAD KING CUSTOM	04	•	1450	FLSTI HR. SOFTAIL	06	•	1450	FXDWGI DYNA WIDE GLIDE	04	•
				1450	FLSTN/I SOFTAIL DELUXE	05	•	1450	FXDWGI DYNA WIDE GLIDE	05	•



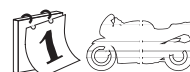
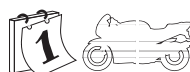
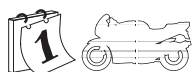

1450 FXDX DYNA SUPER GLIDE SPORT 00 > 03 •

1450 FXDX DYNA SUPER GLIDE SPORT 04 •

1450 FXDX DYNA SUPER GLIDE SPORT 05 •

1450 FXDX DYNA SUPER GLIDE T-SPORT 00 > 03 •

1450 FXST/I SOFTAIL STANDARD 00 > 04 • •

1450 FXST/I SOFTAIL STANDARD 05 > 06 •

1450 FXST/I SOFTAIL STANDARD 06 •

1450 FXSTB/I NIGHT TRAIN 00 > 04 • •

1450 FXSTB/I NIGHT TRAIN 05 •

1450 FXSTB/I NIGHT TRAIN 06 •

1450 FXSTD/I SOFTAIL DUECE 00 > 04 •

1450 FXSTD/I SOFTAIL DUECE 05 •



07HD18.SP 97,5x 63,6x 8

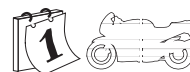
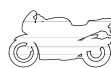
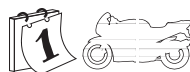
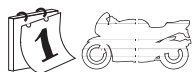
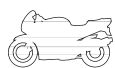
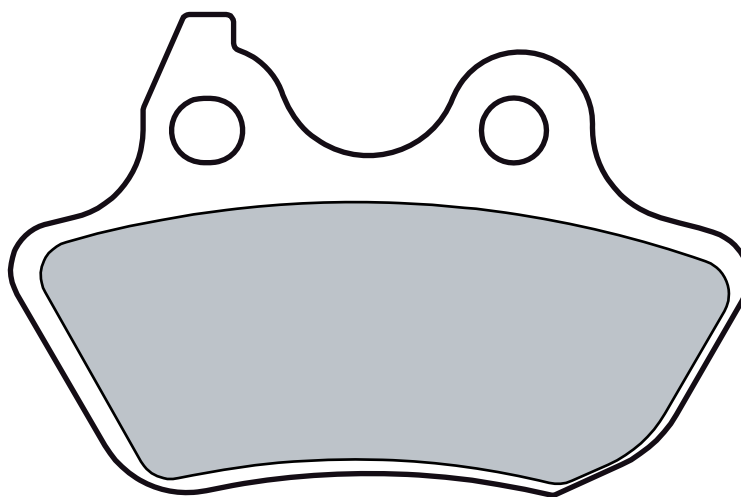
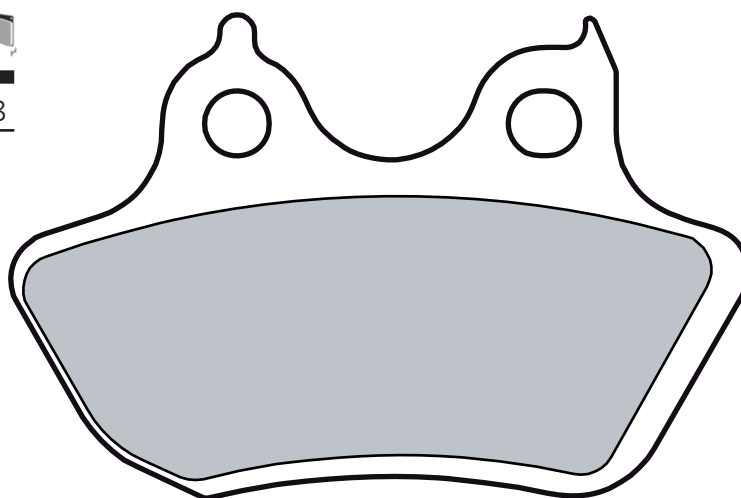

HARLEY DAVIDSON

883 XL R SPORTSER 00 > 03 •

883 XL Sportster Custom 00 > 03 •

883 XLH SPORTSTER 00 > 03 •

883 XLH SPORTSTER HUGGER 00 > 03 •

1130 VRSCA V-ROD 02 •

1130 VRSCB V-ROD 04 •

1200 XL SPORTSTER CUSTOM 00 > 03 •

1200 XL SPORTSTER SPORT 00 > 03 •



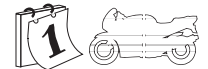
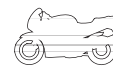
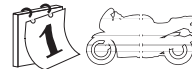
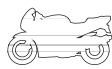
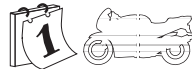
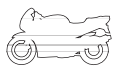

1200 XLH SPORTSTER	00 > 03	•
1450 FLHR/I ROAD KING	00 > 04	•
1450 FLHR/I ROAD KING	05	•
1450 FLHRCI ROAD KING CLASSIC	00 > 04	•
1450 FLHRCI ROAD KING CLASSIC	05	•
1450 FLHRS/I ROAD KING CUSTOM	04	•
1450 FLHRS/I ROAD KING CUSTOM	05	•
1450 FLHT/I EL. GLIDE STANDARD	00 > 04	•
1450 FLHT/I EL. GLIDE STANDARD	05	•
1450 FLHTC/I EL. GLIDE CLASSIC	00 > 04	•
1450 FLHTC/I EL. GLIDE CLASSIC	05	•
1450 FLHTCUI ULTRA CLASSIC EL. GLIDE	00 > 04	•
1450 FLHTCUI ULTRA CLASSIC EL. GLIDE	05	•
1450 FLHXI STREET GLIDE	06	•
1450 FLSTC/I HR. SOFTAIL CLASSIC	00 > 04	•
1450 FLSTC/I HR. SOFTAIL CLASSIC	05 > 06	•
1450 FLSTC/I HR. SOFTAIL CLASSIC	07	•
1450 FLSTF/I FAT BOY	00 > 04	•
1450 FLSTF/I FAT BOY	05	•

1450 FLSTI HR. SOFTAIL	06	•
1450 FLSTN/I SOFTAIL DELUXE	05	•
1450 FLSTS/I HERITAGE SPRINGER	00 > 03	•
1450 FLSTSC/I SPRINGER SOFTAIL CLASSIC	05 > 06	•
1450 FLSTSC/I SPRINGER SOFTAIL CLASSIC	07	•
1450 FLTR/I ROAD GLIDE CLASSIC	00 > 04	•
1450 FLTR/I ROAD GLIDE CLASSIC	05	•
1450 FXD DYNA SUPER GLIDE	00 > 03	•
1450 FXDBIDYNA STREET BOB	06	•
1450 FXDC/I DYNA SUPER GLIDE CUSTOM	05	•
1450 FXDI 35th ANN. SUPER GLIDE	06	•
1450 FXDI DUNA SUPER GLIDE	04	•
1450 FXDI DUYNNA SUPER GLIDE	05	•
1450 FXDL DYNA LOW RIDER	00 > 03	•
1450 FXDLI DYNA LOW RIDER	04	•
1450 FXDLI DYNA LOW RIDER	05	•
1450 FXDS DYNA CONVERTIBLE	00 > 02	•
1450 FXDWG DYNA WIDE GLIDE	00 > 03	•
1450 FXDWGI DYNA WIDE GLIDE	04	•

1450 FXDWGI DYNA WIDE GLIDE	05	•
1450 FXDX DYNA SUPER GLIDE SPORT	00 > 03	•
1450 FXDXI DYNA SUPER GLIDE SPORT	04	•
1450 FXDXI DYNA SUPER GLIDE SPORT	05	•
1450 FXDXT DYNA SUPER GLIDE T-SPORT	00 > 03	•
1450 FXST/I SOFTAIL STANDARD	00 > 04	•
1450 FXST/I SOFTAIL STANDARD	05 > 06	•
1450 FXST/I SOFTAIL STANDARD	06	•
1450 FXSTB/I NIGHT TRAIN	00 > 04	•
1450 FXSTB/I NIGHT TRAIN	05	•
1450 FXSTB/I NIGHT TRAIN	06	•
1450 FXSTD/I SOFTAIL DUECE	00 > 04	•
1450 FXSTD/I SOFTAIL DUECE	05	•
1450 FXSTS/I SPRINGER SOFTAIL	00 > 04	•
1450 FXSTS/I SPRINGER SOFTAIL	05 > 06	•
1450 FXSTS/I SPRINGER SOFTAIL	07	•

2



07HD19.SA 61x 46,5x 7,3
07HD19.SC " " "

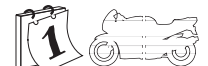
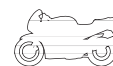
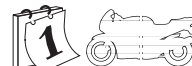
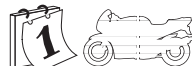
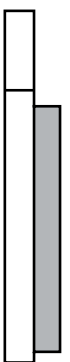
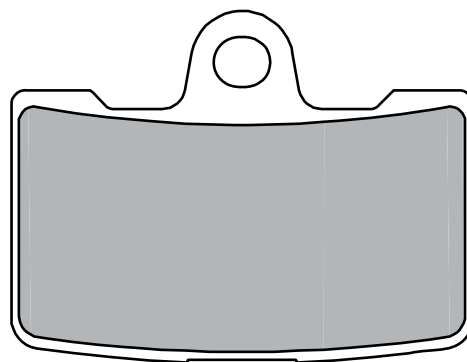

BUELL		
1125 CR	09	•
1125 R	08	•

1200 XB12 R FIREBOLT	09	•
1200 XB12 S LIGHTNING	09	•





07HD20.SA 74,5x 55,2x9,2

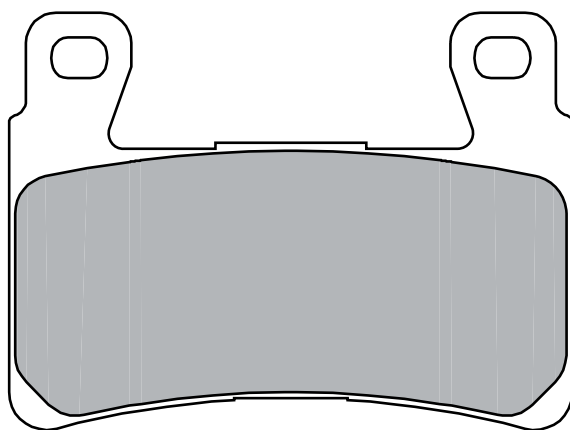

2

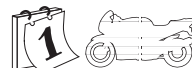
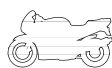
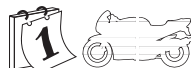
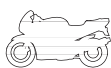
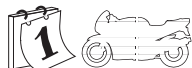
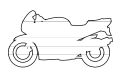

HARLEY DAVIDSON

1200 XR 08 •

