

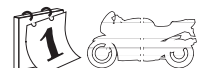

07H001.30 51,6x51,6x19,5
52x 52x 13,7

2

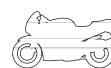
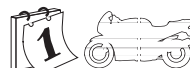
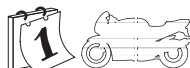
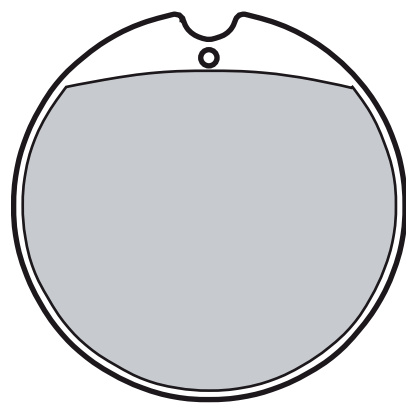
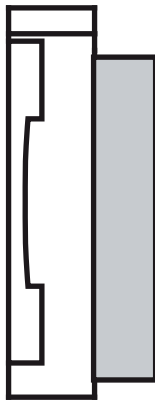
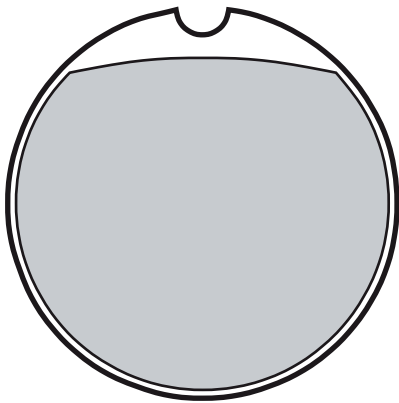

HONDA

250 CB	71	•
250 CB G,T	74 > 76	•
250 CJT	76 > 78	•
350 CB F, F1	73 > 76	•
360 CB G, T	73 > 76	•
360 CJT	76 > 78	•

360 CL K1	74	•
400 CB F, F1, F2	75 > 79	•
450 CB K5, K6, K7	72 > 77	•
500 CB F	72 > 75	•
500 CB K1, K2, K3	72 > 77	•
500 CB T, T1	75 > 78	•
550 CB F1, F2	75 > 79	•

550 CB K2, K3	74 > 78	•
750 CB A, K	76 > 77	•
750 CB F1	75 > 77	•





07H002.29 49,9x49,9x 20
49,9x49,9x13,5

2

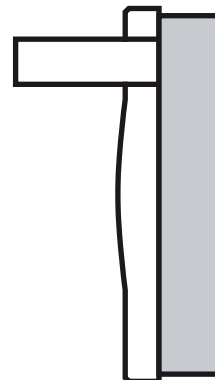
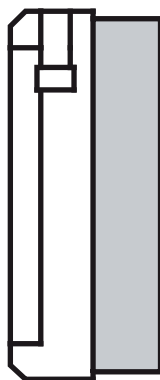
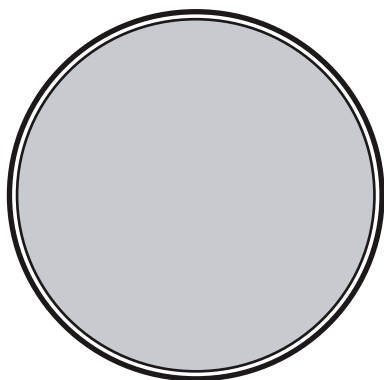

HONDA

450 CB K3, K4	71 > 72	•
750 CB K	70 > 76	•



07H003.07 66,9x 49,1x 9,5

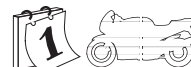
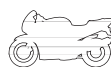
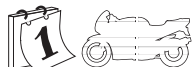
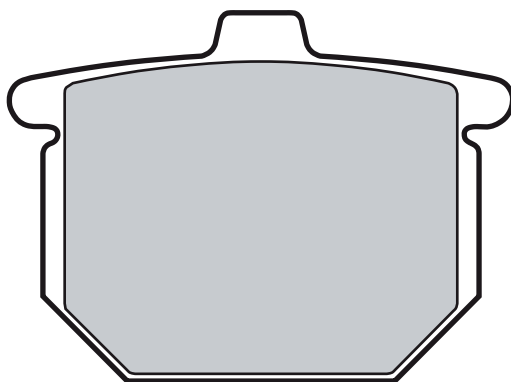

HONDA

125 MT R	78	•
400 CB	78 > 82	•
400 CB NA, NB	78	•
400 CB NZ	79	•

400 CX	81	•
400 GL	77 > 80	•
500 CX	78 > 80	•
750 CB F	77 > 80	• •
750 CB F2, SS	77 > 79	•

900 CB F	78 > 80	• •
1000 CBX	78 > 80	• •
1000 GL GOLDWING, GRANTOUR	81	• •
1000 GL K3	78 > 79	•
1100 GL	79	• •





07H004.11 57,7x65,3x10,5

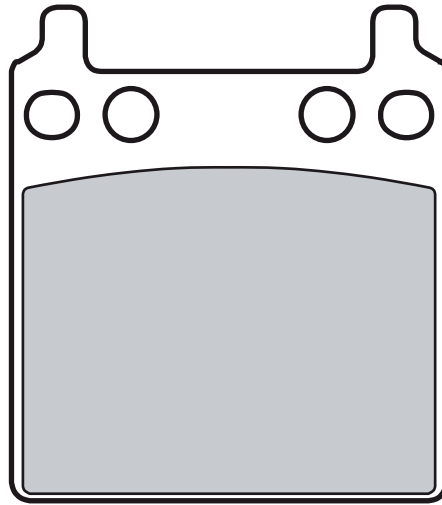

2

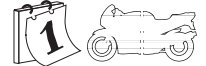
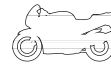
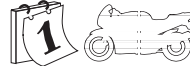
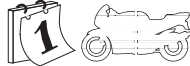
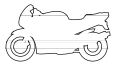

HONDA

750 CB F1 75 > 77 •

1000 GL K1, K2 75 > 77 •

1000 GL K3 78 > 79 •



07H006.31 39,3x 39,3x 21
39,3x 39,3x 11

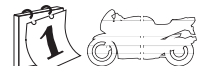
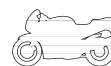
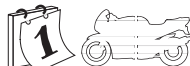
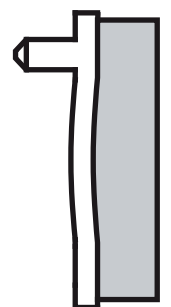
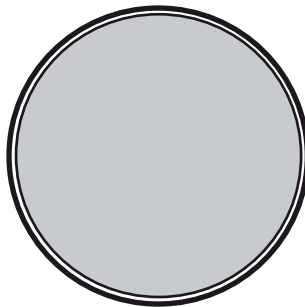

HONDA

50 CB K1, J 75 •

50 SS ZB2 75 •

90 9CB 79 •

110 CB 77 •

125 125 4T 75 •

125 CB 77 •

125 CB J 79 •

125 MT R 77 •





07H007.12 52,5x52,9x 11

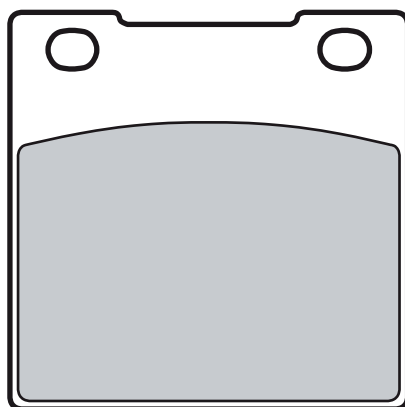

2

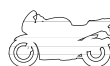

HONDA

250	CB N	78	•
250	CB ND	83	•
250	CB PSA, RSA, RDS	80	•
250	CB RS	80 > 85	•
250	CB RSC, RZC	82	•
250	CB T, TZ, NA, NB	77	•

250	CM TB	81	•
400	CB A, T1, T2	77 > 81	•
400	CB N, T, HAWH	78	•
400	CM A, T, TZ	79	•
400	CM T	79 > 84	•
400	CM T, CUSTOM	81	•
650	CB	80	•

650	CB Z	78 > 81	•
750	CB C, PZ, K, L	80 > 81	•
750	CB CUSTOM	81	•

KAWASAKI

250	CB RS	80 > 84	•
400	CMT	79 > 81	•



07H008.31 39,3x 39,3x 21
39,3x 39,3x 11

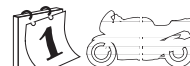
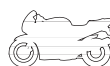
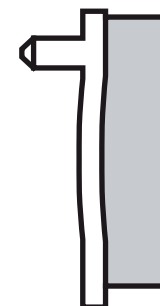
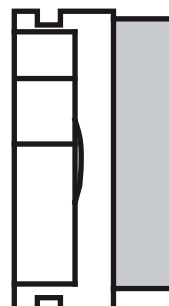
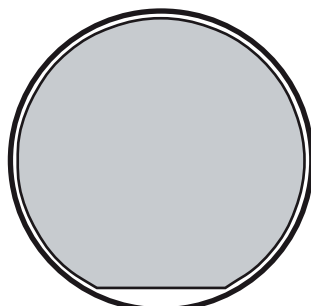

HONDA

100	CB N	79	•
-----	------	----	---

125	CB T	85	•
125	CB T, T1, T2, TZ	77	•

250	FL ODISSEY	84	•
-----	------------	----	---





07H009.SD	41,1x	45x	8
07H009.SX	"	"	"
07H009.TT	"	"	"
07H009.06	"	"	"

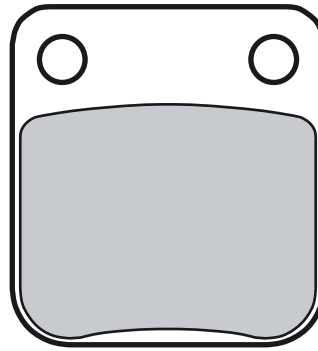

2

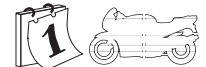
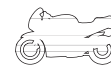
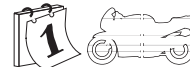
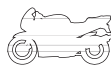
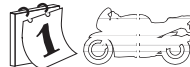

ARCTIC CAT

400 DVX	04	•
---------	----	---

DAELIM

125 S2	05	•
250 S2	06	•

HONDA

50 CB (all models)	80 > 81	•
50 CRM	89 > 92	•
50 MB	82	•
50 MBX	80	•
50 MRX	88	•
80 CB	80 > 81	•
80 CR R	86 > 91	•
80 CR R	92 > 97	•
80 MBX FWD	83	•
125 CB RS	83	•
125 CG	04	•
150 CG	04	•
250 ATC R	81	•

HUSQVARNA

125 CR	92 > 94	•
125 WR	92 > 94	•
250 CR	92 > 94	•
250 WR	92 > 94	•

350 TE	92 > 94	•
--------	---------	---

HYOSUNG

400 TE	05	•
450 TE	07	•

KAWASAKI

125 BN ELIMINATOR A1, A2	98 > 99	•
400 KFX	02	•
400 KVF A1, A2, B1 Prairie	97 > 98	•
400 KVF C1, C2 Prairie 4x4	99	•
400 KVF D1, D2 Prairie 2x4	99	•

SUZUKI

125 123 DR SF	85	•
125 DR	91 > 02	•
125 GX R	88	•
125 RH X	87	•
125 SP	85 > 88	•
125 TS X	85	•
200 DR	90	•
200 SP GHJ	88	•
240 RH X	87	•
240 TS X	85	•
250 DR S, F	85 > 89	•
250 LT-Z Quad Sport	04	•
250 OZARK	03	•

250 RH	85	•
250 SP F	85	•
250 TS X	85	•
400 LT-A Eiger 2WD/4WD	02	•
400 LT-F Eiger 2WD/4WD	02	•
400 LT-Z Quad Sport	02	•
500 LT-A VINSON	02	•

YAMAHA

125 SX R	88	•
200 YFS R Blaster	03	•
250 YFM AN Bruin 2x4	05	•
250 YFM Bear Tracker	01	•
300 YFM Warrior	89	•
350 YFM Bruin 2x4, 4x4	04	•
350 YFM FWB L, LC Big Bear (4WU/EBE)	99	•
350 YFM FXG-FXM Wolverine (4KB/EBE)	95 > 96	•
350 YFM XG,XH Warrior (3GD/EBE)	95 > 96	•
350 YFM XW, XA-M Warrior	89	• •
350 YFZ A-M Banshee	90 > 06	•
400 YFM FAM Kodiak	00	•
400 YFM FWN Big Bear 4WD	00	•
400 YFM FWNH Big Bear-Buckmaster 4WD	00	•
400 YFM N Big Bear 2WD	00	•
450 YFM FA_ Kodiak	03	•
450 YFM KODIAK	03	•
450 YFM Wolverine	06	•





07HO10.SA	89,9x	49x	11
07HO10.SP	"	"	"
07HO10.10	"	"	"

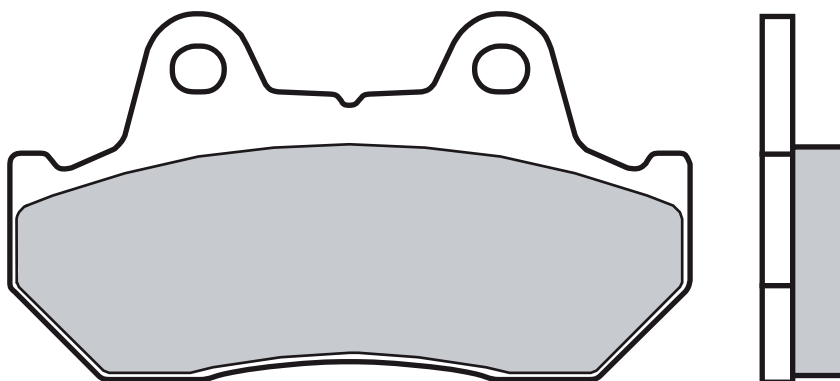

2



HONDA

125	CB TDC	83	•
250	GB CLUBMAN	88	•
250	NS R	85	•
250	NSR R	87	•
400	CB	81	• •
400	CB FOUR	81	•
400	CB HAWK	81	• •
400	CB N	82 > 85	•
400	CB TWIN	82	•
400	CBR F, F2	85	• •
400	CBR R	87	•
400	CM C	81	•
400	CM T	85	•
400	GB TT	88	•
400	NS R	85 > 86	•
400	XELVIS	92	• •
450	CB T	82	•
450	CBR SR	91	• •
450	CM A, C	82	•
450	CMX REBEL	86	•
500	CB EC	83	•
500	CX	81	•
500	CX C	81	• •
500	CX E	85	• •
500	CX EURO	82	•
500	CX SILVER WING TURBO	81 > 83	• •
500	CX TURBO	81 > 83	•
500	FT	82 > 83	• •
500	GB TT	88	•
500	GL	81 > 82	•

500	GL D	81	•
500	NS R	85	• •
500	VF 2	83	•
500	VT C	83 > 86	•
500	XBR S	85	•
550	CB SC	83	•
550	CBX	82	• •
600	CBR F	87 > 90	•
600	CBX E	85	•
600	XL LM	85 > 87	•
600	XL V TRANSALP	87 > 90	•
650	CB	85	•
650	CB SC	83	•
650	CBX ED, SC, SCD	83	•
650	CX C, T, TD, TURBO	83	• •
650	CX E	83	•
650	GL D	83	•
700	CB SC	84	•
700	VF F INTERCEPTOR	84 > 85	•
700	VF S	84	•
700	VFC MAGNA	84	•
700	VFC MAGNA	87	•
700	VFR F, F2	86 > 87	•
700	VT C, SHADOW	87	•
750	CB F, F2, K	85	•
750	CB F, K	81 > 82	• •
750	CB SC, KZ, C	82 > 83	•
750	CBR HURRICANE	87	•
750	CBX, F	84	• •
750	NV CG, SHADOW	86	•
750	VF C	88 > 93	•

750	VF CUSTOM, SPORT	82 > 83	•
750	VF F	83	• •
750	VF S	85	•
750	VFR FJ, F	86 > 87	•
750	VP CH, CUSTOM	87	•
750	VT C, SHADOW	86 > 96	•
750	XLV R	83 > 85	•
800	VT C	88	•
900	CB C	82	• •
900	CB F, F2 BOL D'OR	81 > 84	• •
1000	CB C	83	• •
1000	CBR F	87 > 88	•
1000	CBX	81 > 82	•
1000	VF F	84	• •
1000	VF F2 BOL D'OR, F, F2	85	• •
1000	VF R	84 > 86	•
1000	VF R	86	• •
1000	VT C	88	•
1100	CB F	83 > 85	• •
1100	CB R, RB, RC	81	• •
1100	CB RD	83	• •
1100	GL	81 > 83	• •
1100	VF C, S	83	•
1100	VT SHADOW	87 > 93	•
1200	GL A, I	84	• •
1200	GL DX	86	• •
1200	GL GOLDWING	84	• •
1500	GL ASPENCADE, SE	94 > 97	•
1500	GL GOLDWING SE	88 > 93	•
1500	GL GOLDWING SE	88	•
1500	GLX	88	•





07H011.18 84,9x42,4x 7,8
47,4x 37x 10



2

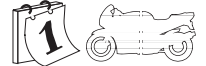
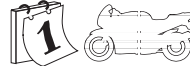
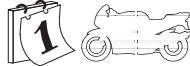
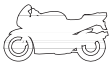

HM

50	CRE	98	•
50	CRE BAJA	97	• •

HONDA

80	MB	80	•
----	----	----	---

80 MCX

82 •

KAWASAKI

80	KMX	87	•
125	KMX	87 > 90	•

SUZUKI

80	RM G	86 > 89	•
80	RM L, M, N	90 > 95	•



07H012.12 66,9x 49,1x 12

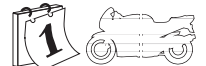
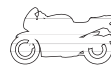
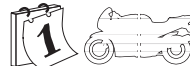
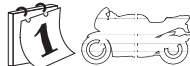
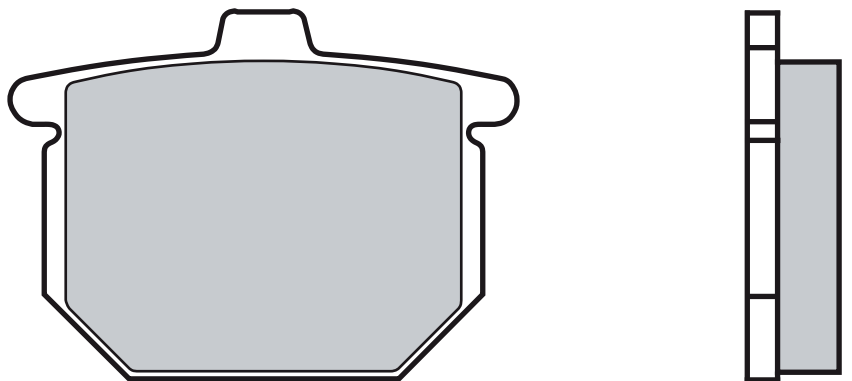

HONDA

750	CB F2, S5	77 > 79	•
1000	GL K1, K2	75 > 77	•





07H013.SP 99,3x 37,8x 9,2
07H013.CC " " "

2

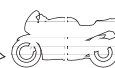
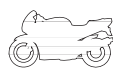
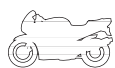
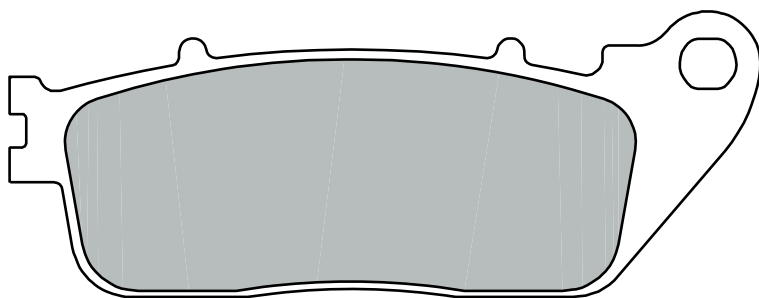
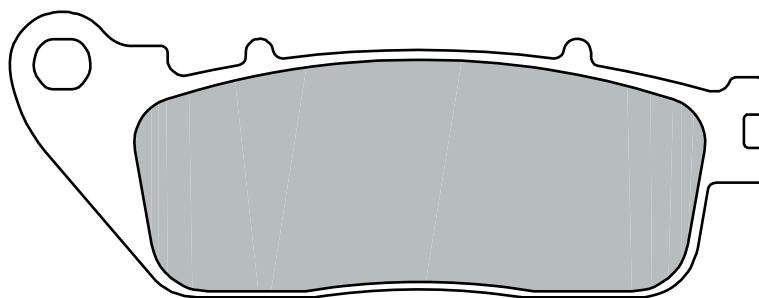

HONDA

1000 CB R

08





07H014.06 91,7x 53,2x 8

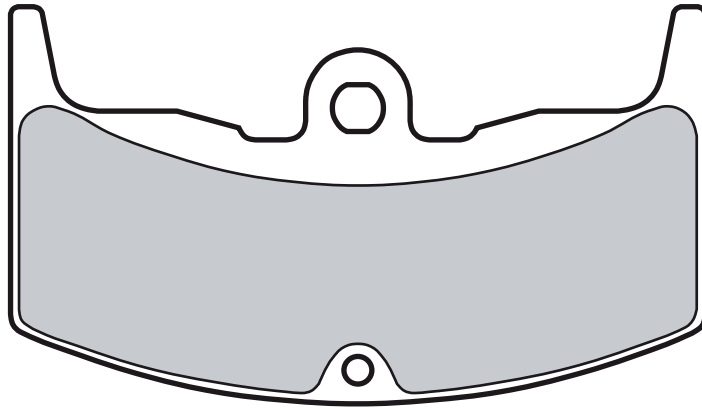

2

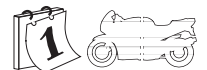
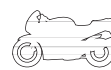
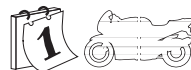
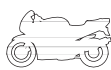
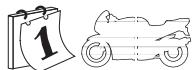

HONDA

250 VT E, FD	83	•
250 VT F	83 > 87	•
250 VTR	88 > 89	•
400 CBX F, F2, F2C	82	•

400 VF F	85	•
400 VF FD	83	•
400 VT E	83	•
400 VT FD	83	•
500 VT E	83	•

500 VT ED	82	• •
550 CBX F, F2, FC, F2C	82	•
650 CBX E	83	• •
900 CB FC, F2C	82	•





07H015.SD 80,9x 41,7x 7,3

07H015.SX " " "

07H015.TT " " "

07H015.05 " " "

2

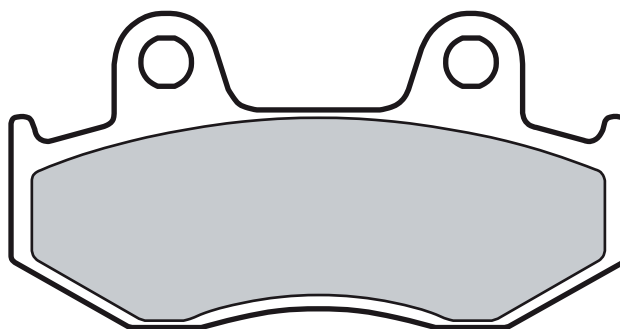

HONDA

80	MBX	86	•
80	MTX R	87	•
125	CR R	84 > 86	•
125	MTX	90	•
125	MTX R	84 > 85	•
125	XL R	86	•
200	ATC R	85	• •
200	MTX R	86	•
250	ATC R	85 > 86	• •
250	ATC X	85	•

250	CB RS	86	•
250	CR R	84 > 86	•
250	FTR	86	• •
250	TRX R	86 > 89	•
250	TRX X Fourtrax	87	•
250	XL R	84 > 87	•
250	XLR R	88	•
250	XR RE	84 > 87	•
350	ATC X	85	•
350	XL R	84 > 86	•
350	XL R ND 03	84	•

350	XR R	84 > 85	•
500	CR R	84 > 86	•
500	XL R	83 > 84	•
500	XR R	83 > 86	•
600	XL R	83	•
600	XL R, RD, LD	83	•
600	XLM LM	87	•
600	XR R	83 > 87	•





07H016.09 89,9x 51,1x 9,9

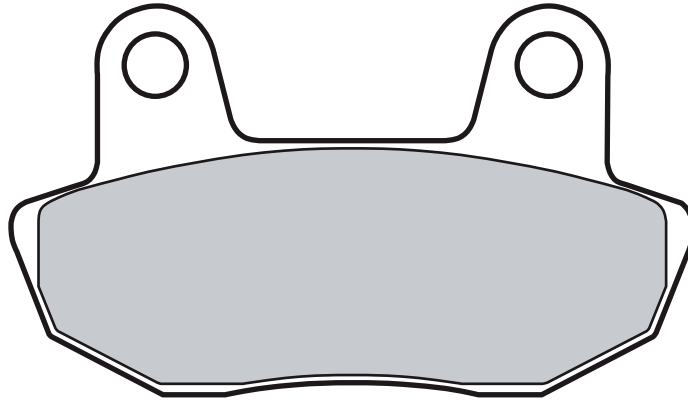

2

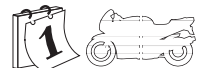
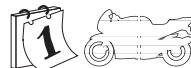
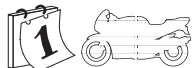

HONDA

450	CB N	84 > 85	•
450	CB SC NIGHTHAWK	82	•

650	CB SCC NIGHTHAWK	82	•
700	VT C, SHADOW	84 > 86	•
750	VT C	83 > 85	•





07H017.08 91,7x 53,2x 9,5

2

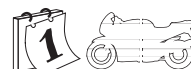
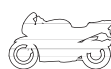
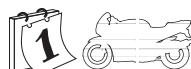
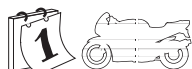
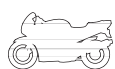
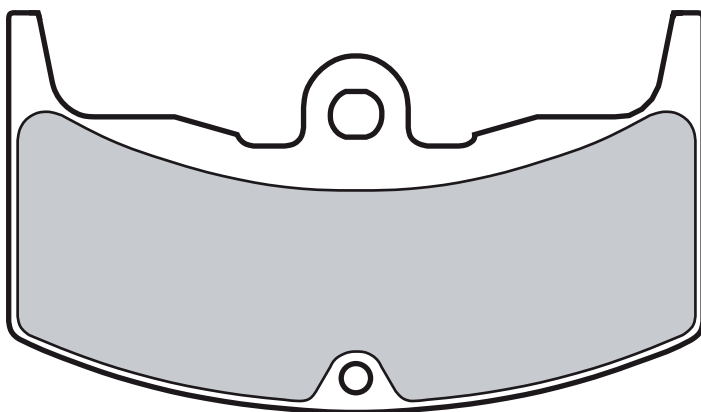

HONDA

400	CBX CUSTOM	88	•
400	CBX F	85	• •
400	CBX F, F2, F2C	82	•
400	NV CUSTOM	88	•

400	VF F	85	•
400	VF FD	83	•
400	VT E	83	•
400	VT FD	83	•
550	CBX F, F2, FC, F2C	82	•

900	CB FC, F2C	82	•
-----	------------	----	---





07H018.SP 89,9x 49x 9
07H018.07 " " "

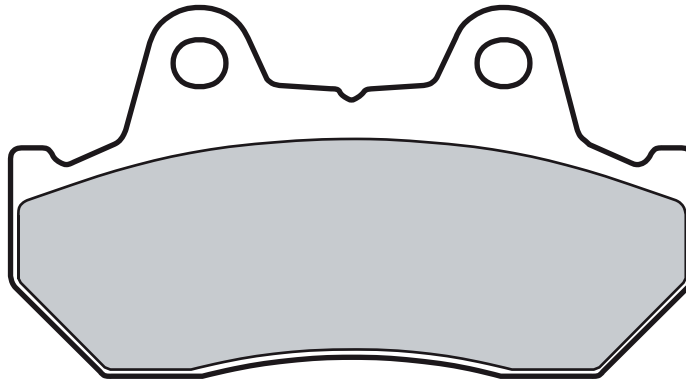

2

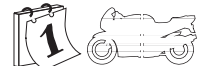
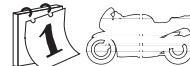
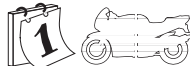
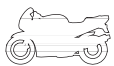

HONDA

125 CB T, SUPERDREAM	82	•
125 CBX F	88	•
250 CBX RSE	84	•
250 CBX S	88	•
250 NS R	85	•
400 NS R	85 > 86	•

400 VF INTEGRA	86	• •
450 CB SC NIGHTHAWK	83 > 86	•
500 CB EC	83	•
500 CX EURO	82	•
500 CX TURBO	81 > 83	•
500 GL	81 > 82	•
500 VF 2	83	•

650 CX E	83	•
700 VF F INTERCEPTOR	84 > 85	•
700 VFC MAGNA	85 > 86	•
750 XLV R	86	•
1000 CBX	81 > 82	•
1100 VF C, S	83	•



07H019.12 49,9x54,8x11,3

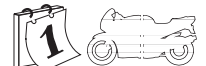
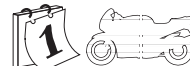
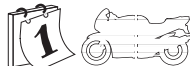
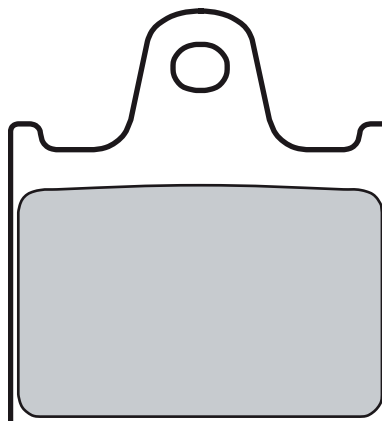

HONDA

1000 VF R	84 > 86	•
-----------	---------	---





07HO20.SD	45,9x	45x6,5/7,5
07HO20.SX	"	" "
07HO20.TT	"	" "

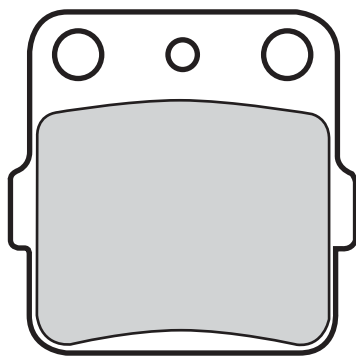

2

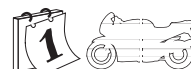
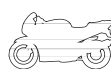
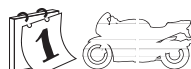
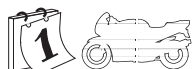
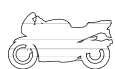

HONDA

200	ATC X	83 > 85	•
200	ATC XD	83	•
250	ATC R	82 > 84	•
250	ATC X	85	•

350	ATC X	85	•
350	ATC X	86	•

SUZUKI

230	LT SG	86	•
-----	-------	----	---





07H021.SA 81,1x 42,1x 8,9
07H021.SC " " "
07H021.07 " " "

2

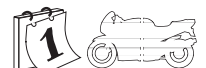
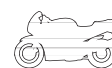
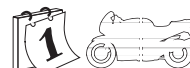
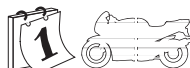
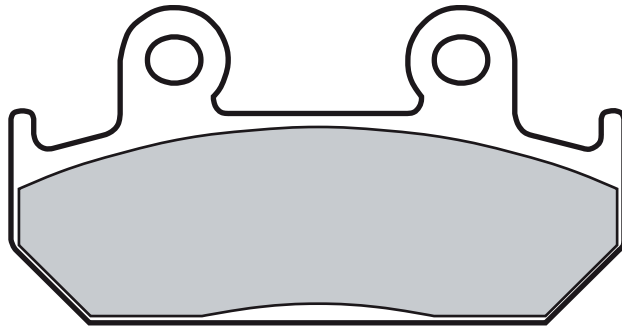

HONDA

250 CBR F	86	•	350 CB S, G	87	•	400 VFR Z	88	•
250 CBR HURRICANE	87	•	350 NX	92	•	450 CB S	86	•
250 NSR R	87	•	400 CB N	86	•	600 CBR F	87 > 90	•
250 VT F	88	•	400 CBR F	92	•	600 CBR F, SUPER SPORT	91 > 94	•
250 VTR	90 > 97	•	400 CBR R	87	•	600 NTV REVERE	88	•
250 VTZ	88	•	400 VFR R	86 > 87	• •	600 VT SHADOW CUSTOM	89 > 91	•
			400 VFR R	87 > 90	•	750 XRV AFRICA TWIN	90 > 92	•





07H022.SD	45,9x	45x	6,5
07H022.SX	"	"	"
07H022.TT	"	"	"
07H022.05	"	"	"

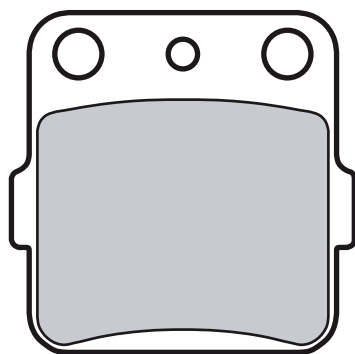

2

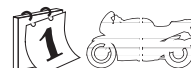
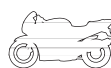
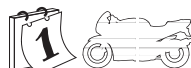
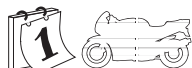

HONDA

75	CRM R	92	•
80	CR	03	•
80	CR R, RB	96 > 02	•
80	CRM	89	•
200	ATC XD	83	•
250	ATC R	82 > 84	•

SUZUKI

125	RM H	87 > 88	•
230	LT EH, S	86 > 93	•
230	LT SF-SJ	85 > 88	•
250	LT RF-RH	85 > 87	•
250	RM H	87 > 88	•

YAMAHA

125	YZ	89	•
250	YZ	89	•
300	YFM Warrior	89	•
350	YFM XT	87 > 88	•
360	YZ	89	•





07H023.SA	88,2x46,1x8,4
07H023.SP	" " "
07H023.07	" " "

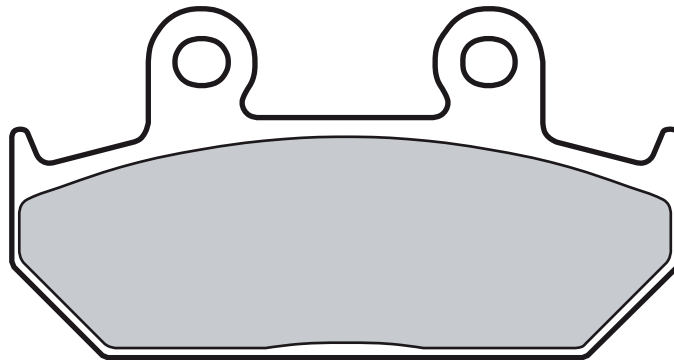

2

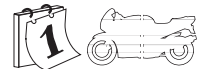
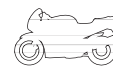
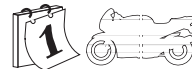
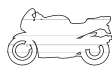
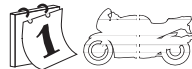
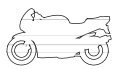

CAGIVA

600 CANYON 95 •

HONDA

125 RS (GP) 88 > 90 •
 250 CB 88 > 91 •
 250 CD 88 •

400 STEED 88 > 91 •
 600 NV C 88 •
 600 NX DOMINATOR 93 •
 600 STEED 88 > 91 •
 650 NX DOMINATOR 93 > 96 •
 700 VFR F, F2 86 > 87 •
 750 CBR HURRICANE 87 •

750 VFR FJ, F 86 > 87 •
 1000 CBR F 87 > 88 •



07H024.08	54,9x52,4x 9,4
------------------	----------------

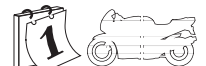
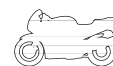
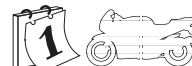
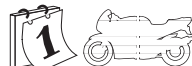
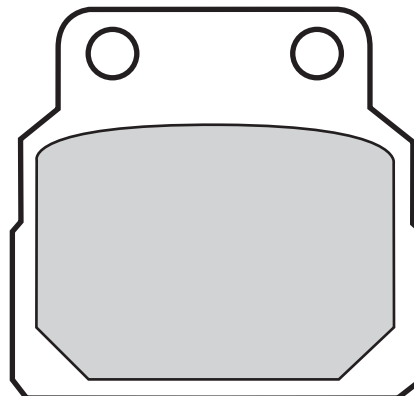

HONDA

450 CB DX 89 • •
 450 CB N 86 •





07H025.SD	94x 31,9x7,4
07H025.SX	" " "
07H025.TT	" " "
07H025.06	" " "

2

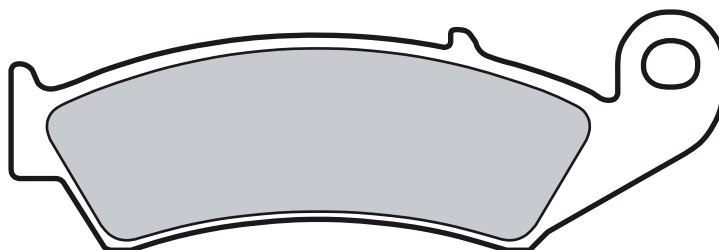

HONDA

125 CR R, RK	87 > 94 •
250 AX 1	88 •
250 AX-1	90 •
250 CR R	87 > 94 •
250 CRM R	90 •
250 NX	88 > 90 •

250 TRX R	86 > 89 •
250 TRX X Fourtrax	87 •
250 XL DEGREE	91 •
250 XLR BAJA	88 > 90 •
250 XR R	88 > 89 •
250 XR R, L	90 > 93 •
350 ATC X	86 •

500 CR	87 > 94 •
600 XR R	88 > 90 •
600 XR R	91 > 92 •





07HO26.SD	74,9x36,1x9,5
07HO26.SX	" " "
07HO26.TT	" " "
07HO26.08	" " "

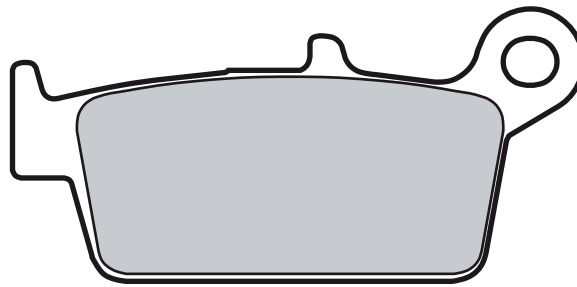

2

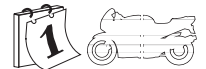
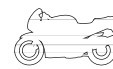
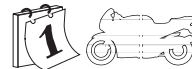
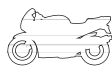
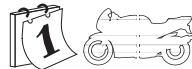
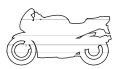

FANTIC MOTOR

50	MX Regolarità Competizione	08	•
65	MX Regolarità Competizione	08	•
85	MX Regolarità Competizione	08	•

GAS GAS

125	EC	00	•
125	MC	03	•
125	SM	02	•
200	EC	00	•
200	HOBBY	07	•
250	EC	00	•
250	MC	00	•
250	SM	02	•
300	EC	00	•
400	EC	02	•
400	FSE SM	02	•
400	PAMPERA	06	•
450	EC	03	•
450	FSE EC	03	•
450	FSE SM	03 > 06	•
450	FSR	07	•
450	SM FSR	07	•
500	FSE EC	06	•
515	FSR	08	•

HM

50	CRE	06	•
125	CRE ENDURO	95 > 01	•
125	CRE R ENDURO	02	•
125	CRE SUPERMOTARD	03	•
125	SUPERMOTARD	00	•
250	CRE ENDURO	95 > 01	•
250	CRE SUPERMOTARD	03	•
250	CRE SUPERMOTARD	04	•
250	SUPERMOTARD	00	•

HONDA

50	CB Replica	99	•
80	MB	80	•
80	MCX	82	•
80	MCX S	82	•
80	MTX R	87	•
125	CA REBEL	95 > 96	•
125	CR R, RK	87 > 94	•
125	CR RK	95 > 01	•
230	SL	97	•
250	AX 1	88	•
250	CR R	87 > 94	•
250	CR R	95 > 01	•
250	XLR BAJA	88 > 90	•
250	XLR R, SPL	94	•
250	XR R, L	90 > 93	•
250	XR R, L, S	94	•
400	XR	96	•
400	XR SUPERMOTARD	00	•
440	XR R	00	•
500	CR	87 > 94	•
500	CR	95 > 01	•
600	XR R	91 > 92	•
600	XR R	93	•
650	BROS	88	•
650	NTV HAWK	89 > 91	•
650	XR L	93	•
650	XR R	00	•

HYOSUNG

400	XRV	05	•
-----	-----	----	---

KAWASAKI

125	KX	95	•
250	KLX	98	•
250	KLX 250	09	•
250	KX	95	•

300	KLX R	97	•
400	KLX R/SR	03	•
500	KX	96	•
650	KLX R	96 > 98	•

SHERCO

450	ENDURO	04	•
-----	--------	----	---

SUZUKI

125	RM T	96 > 05	•
250	DR Z	01	•
250	RM T	96 > 05	•
250	RMX	99	•
400	DR-Z S/E	00 > 04	•

TM

85	85	01	•
125	125	01 > 04	•
125	ENDURO	01 > 04	•
125	SMR	05	•
125	SMX	06	•
250	250	01 > 04	•
250	250 4-stroke	01	•
250	E	01	•
250	E 4-stroke	01 > 04	•
300	300	01	•
300	E	01 > 04	•
400	4T	01	•
400	E 4 stroke	01	•
400	SMR F	02	•
400	SMR F	03	•
450	4T	02 > 04	•
450	ENDURO 4 stroke	02 > 04	•
450	SMR F	04	•
450	SMX F	03	•
530	4T	01 > 04	•
530	E 4 stroke	01 > 04	•



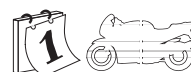
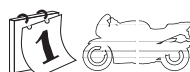
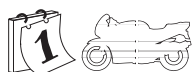

530	SMR F	03	•
530	SMR F ES	03	•
600	SMX F	03	•
660	SMX F	05	•

YAMAHA

125	WR	98	•
-----	----	----	---

125	YZ	98 > 02	•
250	WR	98 > 02	•
250	WR F	01 > 02	•
250	YZ	98 > 02	•
250	YZ F	01 > 02	•
400	WR F	99 > 00	•
400	YZ F	99 > 02	•

426	WR F	01 > 02	•
426	YZ F	00 > 02	•



07H027.SP 86,1x39,9x10,7
07H027.11 " " "

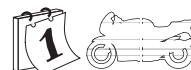
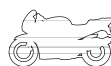
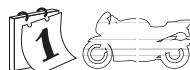
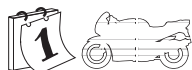
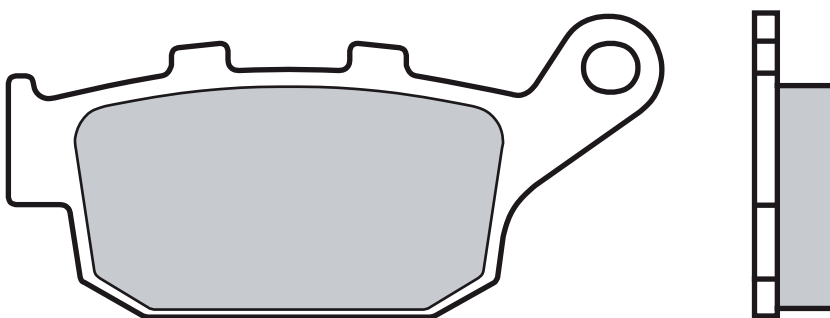

BUELL

500	BLAST	01	•
984	XB 8 R	02	•
984	XB 8 S	03	•
984	XB 9 SX CITY X	05	•
1200	M2	98 > 02	•
1200	RS X1	98	•
1200	S1 LIGHTNING	98 > 02	•
1200	S1 WHITELIGHT TWIN	98 > 02	•
1200	S3 THUNDERBOLT	98 > 02	•
1200	XB12 R	04	•
1200	XB12 R FIREBOLT	09	•
1200	XB12 S LIGHTNING	04 > 08	•
1200	XB12 S LIGHTNING	09	•
1200	XB12 STT SUPER TT	07	•
1200	XB12 X ULYSSES	06	•

HONDA

250	CBR HURRICANE	87	•
250	CBR R, RR	90	•
250	CBR RJ	88	•
250	NSR RJ, R, SP	88	•
250	RS R	91 > 92	•

250	VT SPADA	89	•
250	VTR	98	•
400	BROS 2	88	•
400	CB FK	90	•
400	CB SUPER FOUR	92	•
400	CB-1	89 > 90	•
400	CBR RR	88 > 94	•
400	VFR R	91	•
400	VFR Z	88	•
400	VRX T ROADSTER	95	•
600	NTV BROS 1	88	•
600	NTV REVERE	88	•
600	NX DOMINATOR	93	•
600	XL V TRANSALP	91 > 93	•
600	XL V TRANSALP	94 > 96	•
600	XL V TRANSALP	97 > 99	•
650	FMX	05	•
650	NTV	94	•
650	NTV DEAUVILLE	98 > 00	•
650	NTV REVERE	88 > 93	•
650	NTX BROS	90	•
650	NX DOMINATOR	88 > 92	•
650	NX DOMINATOR	93 > 96	•

650	XLV TRANSALP	00	•
650	XRV AFRICA TWIN	88	•
700	VF FR INTERCEPTOR	88 > 89	•
700	XL TRANSALP	08	•
750	CB NIGHTHAWK	91	•
750	XRV AFRICA TWIN	90 > 92	•
750	XRV AFRICA TWIN	93	•

SUZUKI

650	XF FREEWIND	97	•
-----	-------------	----	---

TRIUMPH

600	DAYTONA	04	•
600	SPEED FOUR	03	•
600	TT	00	•
650	DAYTONA	05	•
675	DAYTONA	06 > 08	•
675	DAYTONA TRIPLE 675	09	•
675	STREET TRIPLE	08	•
675	STREET TRIPLE R675	09	•





07HO28.SA	67,8x53,7x8,1
07HO28.SC	" " "
07HO28.RC	" " "
07HO28.07	" " "

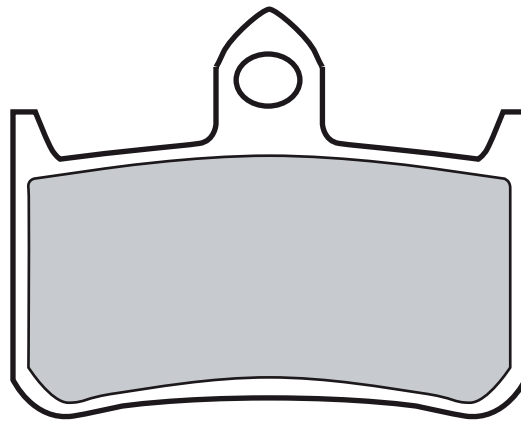

2

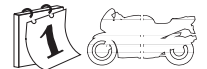
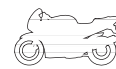
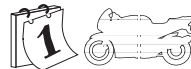
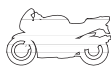
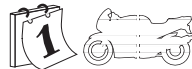
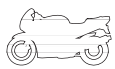

HONDA

125 NS	89	•
250 NS	89	•
250 NSR RJ, R, SP	88	•
250 RS R	91 > 92	•
400 BROS 2	88	•
400 RVF RR	90	•

400 VFR R	91	•
400 VTR R	90	•
600 NTV BROS 1	88	•
650 BROS	88	•
650 NTX BROS	90	•
750 NR	92	•
750 RVF (RC 45)	94	•

750 VFR R (RC 30)	88 > 93	•
900 CBR RR	92 > 97	•
900 HORNET	02	•
1000 CB BIG ONE	93 > 95	•
1000 VTR F FIRESTORM	97	•
1300 CB X-4	97	•



07HO29.SP	94x 31,9x 8,4
07HO29.11	" " "

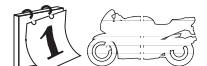
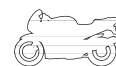
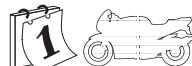
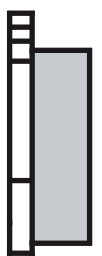
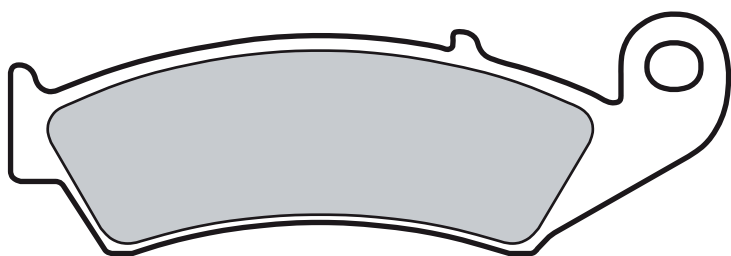

HONDA

400 RVF RR	90	•
400 VFR R	87 > 90	•

400 VTR R	90	•
750 RVF (RC 45)	94	•
750 VFR R (RC 30)	88 > 93	•





07H030.SA	102,1x38,9x8,1
07H030.SC	" " "
07H030.05	" " "

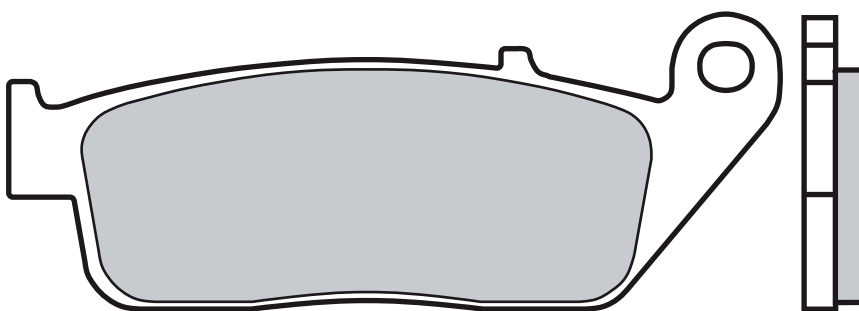

2

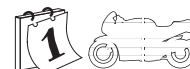
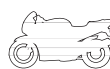
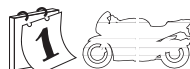
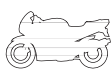
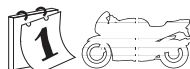
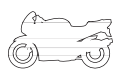

BUELL

500 BLAST	01	•
-----------	----	---

CAGIVA

900 GRAN CANYON	99	•
1000 NAVIGATOR	00	•

HONDA

125 RS (GP)	91 > 94	•
125 XLR R	98	•
125 XR L	03	•
250 CB	92	•
250 CBR NIGHTHAWK	92	•
250 CBR R, RR	90	•
250 CBR RJ	88	•
250 STEED	93	•
250 VT SPADA	89	•
400 CB FK	90	•
400 CB-1	89 > 90	•
400 CBR RR	88 > 94	•
400 STEED	92	•
400 VRX T ROADSTER	95	•
500 CB	94 > 96	•
600 CBF S	04 > 07	•
600 CBR F3	95 > 98	•
600 HORNET	07	•
600 HORNET	98 > 06	•
600 STEED	92	•
600 VT C, SHADOW	93	•
600 VT CD SHADOW VLX	94	•
650 FMX	05	•
650 NTV	94	•
650 NTV HAWK	89 > 91	•
650 NTV REVERE	88 > 93	•
700 VF FR INTERCEPTOR	88 > 89	•

750 CB N, SEVEN FIFTY	92	•
750 CB NIGHTHAWK	91	•
750 VFR F	88 > 89	•
750 VFR F	90 > 97	•
800 PC	89 > 97	•
950 VFR F	92	•
1000 CBR F, FJ, FK	89 > 92	•
1000 VF R	89	•
1100 ST PAN EUROPEAN	90 > 02	•
1100 VT C2 Y	00	•
1100 VT SHADOW	94 > 96	•
1100 VT SHADOW C2	95 > 98	•
1100 VT SHADOW C3	99	•
1300 VTX	03	•
1300 VTX C	04	•
1500 GL C VALKYRIE	96	•
1500 GLX	97	•

HYOSUNG

250 AQUILA	00	•
------------	----	---

KAWASAKI

750 Z 750	07	•
750 Z 750 ABS	07	•

PEUGEOT

400 SATELIS	07	•
500 GEOPOLIS	08	•

SUZUKI

250 GSF IMPULSE	95	•
400 GSX IMPULSE	94	•
400 RF	93	•
600 GSF BANDIT	95 > 99	•
600 RF R	93 > 96	•

TRIUMPH

675 STREET TRIPLE	08	•
800 AMERICA	03	•
800 BONNEVILLE	01	•
800 BONNEVILLE AMERICA	02	•
800 BONNEVILLE BLACK	04	•
800 BONNEVILLE T100 PAUL SMITH	06 > 08	•
800 SPEEDMASTER	03 > 04	•
865 BONNEVILLE T100	09	•
865 NEW BONNEVILLE	09	•
865 NEW BONNEVILLE SE	09	•
885 THUNDERBIRD SPORT	04	•
900 ADVENTURER	96	•
900 AMERICA	07	•
900 BONNEVILLE	05 > 08	•
900 BONNEVILLE T100	05 > 08	•
900 LEGEND TT	99	•
900 SCRAMBLER	06	•
900 THRUXTON	04	•
900 THUNDERBIRD	03	•
900 THUNDERBIRD	96	•
900 TIGER	99 > 00	•
955 TIGER	04 > 06	•
955 TIGER	01 > 03	•

VOXAN

1000 SCRAMBLER	01	•
----------------	----	---

YAMAHA

250 WR X	08	•
----------	----	---





07H031.SP 102,1x38,9x 9,6
07H031.09 " " "

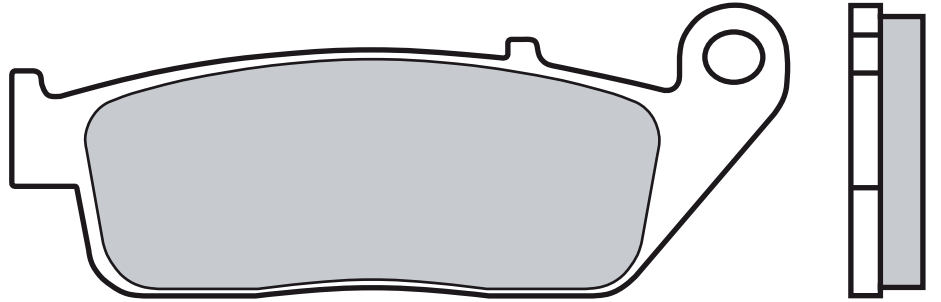

2

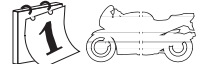
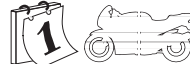
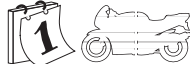

DAELIM

125 DAYSTAR	00	•
125 ROADWIN	04	•
125 ROCKET	99	•
125 S2	05	•
125 VL DAYSTAR	00	•
125 VT EVOLUTION	00	•
125 VT MAGNA	99	•
150 ROADWIN X5	06	•
250 ROADWIN	08	•
250 S2	06	•

HONDA

750 VFR F	88 > 89	•
750 VFR F	90 > 97	•
950 VFR F	92	•
1000 CBR F, FJ, FK	89 > 92	•
1000 VF R	89	•
1500 GL C VALKYRIE	96	•
1500 GLX	97	•

TRIUMPH

885 THUNDERBIRD SPORT	04	•
-----------------------	----	---

900 ADVENTURER	96	•
900 LEGEND TT	99	•
900 THUNDERBIRD	03	•
900 THUNDERBIRD	96	•
900 TIGER	99 > 00	•
955 TIGER	01 > 03	•





07H032.SP	45,9x	45x	7,5
07H032.SD	"	"	"
07H032.SX	"	"	"

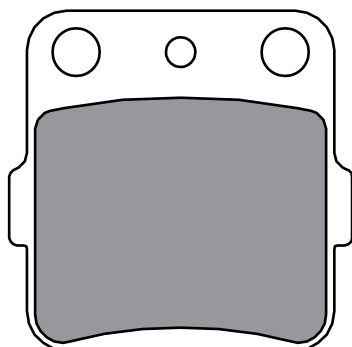

2

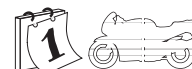
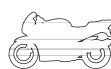
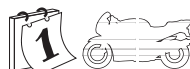
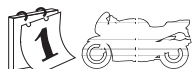

HONDA

85	CR R, R EXPERT	03	•
150	CRF R	07	•
200	ATC X	83 > 85	•
250	TRX EX SPORTRAX	01 > 08	•
250	TRX X	08	•
300	TRX EX SPORTRAX	01 > 08	• •
300	TRX X	09	• •
400	TRX EX SPORTRAX	01 > 08	• •
400	TRX FOURTRAX EX	99	• •
400	TRX X	09	• •
420	TRX FA / FPA	09	•
420	TRX FPE / FPM 4X4	09	•
450	TRX EX SPORTRAX	01	• •

KAWASAKI

65	KX	00	•
80	KX L, N, R	88 > 96	•
80	KX R7, T7, W1, W2, Y1, Y2	97 > 00	•
85	KX, II	01	•
100	KX	88 > 96	•

100	KX	97	•
250	KSF A1-A17 Mojave	87	•
250	KXF A1, A2 Tecate	87 > 88	•
250	KXT B2 Tecate	87	•
300	KEF Lakota	95	•
450	KFX (left cal. + rear cal.)	07	•

SUZUKI

65	RM	03	•
100	RM	03	•
230	LT EH-EP	86 > 93	•
250	LT SK, SL	89 > 90	•
500	RM H	87	•
800	DR Z	88 > 90	•

TM

80	JUNIOR	96 > 00	•
----	--------	---------	---

YAMAHA

80	YZ E, F, G, H1, J1	93 > 01	•
85	YZ	02	•

200	YFS R Blaster	03	•
250	YFM RAPTOR LEFT/REAR	09	•
350	YFM FXG-FXM Wolverine (4KB/EBE)	95 > 96	•
350	YFM R RAPTOR	04	• •
350	YFM XG,XH Warrior (3GD/EBE)	95 > 96	•
350	YFM XT, XU Warrior	87 > 88	•
350	YFZ A-M Banshee	90 > 06	•
350	YFZ T-W Banshee	87 > 89	•
450	YZF S Left/Rear	04 > 05	•
600	YFM FWAK-FWAN 4X4 GRIZZLY	98 > 01	•
660	YFM GRIZZLY FWAP 4X4	02	•
660	YFM RN RAPTOR	01	• •





07H033.CC 39,9x 56,2x 9,5

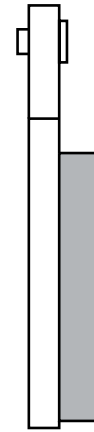
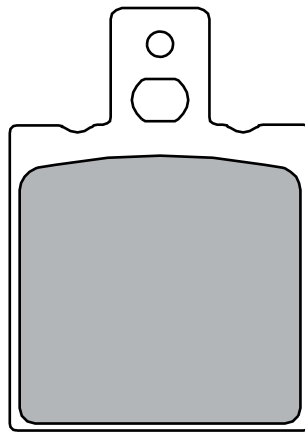

2

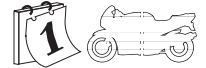
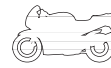
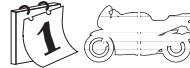
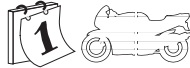

HONDA

125 CRM, R	90 > 98	•
125 NSR F	90 > 92	•
125 NSR R, ITALY	89	•



07H034.SP 102,1x38,9x10,4
07H034.05 " " "

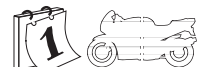
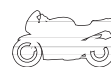
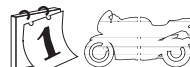
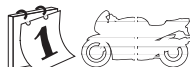
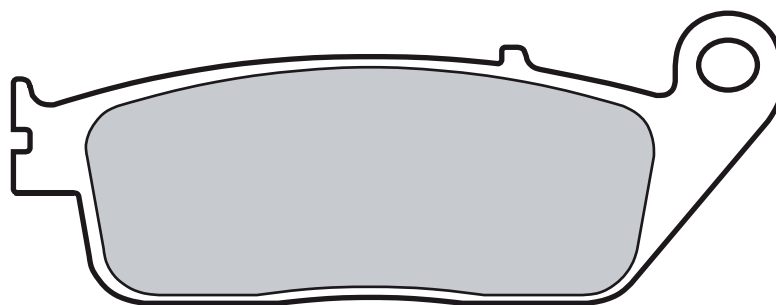

HONDA

250 VTR	98	•
400 CB SUPER FOUR	92	•
750 VF C	94	•
1100 ST ABS-TCS-CBS	92 > 95	•

1100 ST PAN EUROPEAN 90 > 02 •

KYMCO

250 VENOX 01 •

YAMAHA

250 X-CITY	08	•
1700 MT-01	07	•
1700 MT-01	05	•





07H035.SA 88,2x46,1x10,5

07H035.09 " " "

2

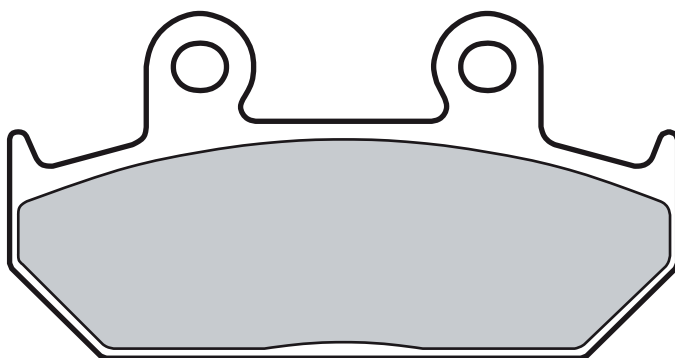

CAGIVA

500 CANYON	99	•
900 CANYON I.e.	97 > 98	•
900 ELEFANT I.e.	90	•

HONDA

125 CB TT	90	•
-----------	----	---

600 VT C, SHADOW	92	•
600 VT SHADOW, CUSTOM	88	•
600 XL V TRANSALP	91 > 93	•
650 NX DOMINATOR	88 > 92	•
650 XRV AFRICA TWIN	88	•
1500 GL ASPENCADE, SE	94 > 97	•
1500 GL GOLDWING SE	88 > 93	•

1500 GL GOLDWING SE	88	•
1500 GLX	88	•





07H036.SP 85,7x 40x 8,9
07H036.07 " " "

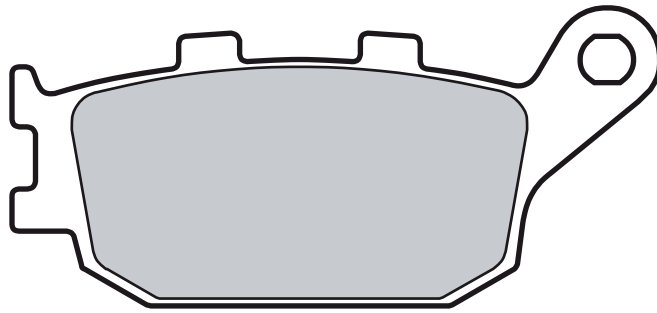

2

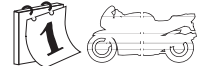
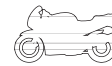
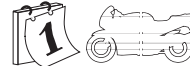
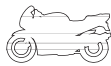
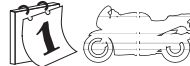
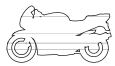

HONDA

400	CBR F	92	•
500	CBF	04	•
500	CBF ABS	04	•
600	CBF	08	•
600	CBF N	08	•
600	CBF S	04 > 07	•
600	CBF S	08	•
600	CBR F, SUPER SPORT	91 > 94	•
600	CBR F3	95 > 98	•
600	CBR F4	99 > 02	•
600	CBR RR	03 > 04	•
600	CBR RR	05 > 06	•
600	HORNET	98 > 06	•
600	HORNET ABS	07	•
650	NTV DEAUVILLE	01 > 02	•
750	CB N, SEVEN FIFTY	92	•
750	NR	92	•
900	CBR RR	98 > 99	•
900	CBR RR	92 > 97	•
900	CBR RR FIREBALDE (954 cc)	02 > 03	•
900	CBR RR FIREBLADE (929 cc)	00 > 01	•
900	HORNET	02	•
1000	CB BIG ONE	93 > 95	•
1000	CBF	06	•

1000	CBF ABS	06	•
1000	CBF1000	09	•
1000	CBR RR	04 > 05	•
1000	VTR F FIRESTORM	97	•
1000	VTR SP01,SP02 (RC 51)	00	•
1100	VT C2 Y	00	•
1100	VT SHADOW	94 > 96	•
1100	VT SHADOW C2	95 > 98	•
1100	VT SHADOW C3	99	•
1300	VTX	03	•

KAWASAKI

750	Z 750	07	•
750	Z 750 ABS	07	•
1000	KLX (right caliper)	04	•
1000	Z	07	•

SUZUKI

650	GLADIUS 650 LEFT/REAR	09	•
650	GSF ABS	07	•
650	GSF S ABS	07	•
650	GSX F	08	•
650	SV (left caliper)	03 > 08	•
650	V STROM (left caliper)	04	•
1000	DLV-STROM (left caliper)	02	•

1000	SV	03	•
1000	SV S	03	•
1250	GSF ABS	07	•
1250	GSF S ABS	07	•
1300	B-KING	07	•

YAMAHA

600	FZ 6	04	•
600	FZ 6 FAZER	04	•
600	FZ6 Fazer S2	07	•
600	FZ6 Fazer S2 ABS	07	•
600	FZ6 S2	07	•
600	FZ6 S2 ABS	07	•
600	XJ 6	09	•
600	YZF R6	03	•
1000	FZ1	06	•
1000	FZ1 FAZER	06	•
1000	YZF R1	07	•
1000	YZF R1	04 > 06	•
1000	YZF R1 SP	06	•





07H039.SA 125,5x44,3 x8,7

07H039.SP " " "

07H039.07 " " "

2

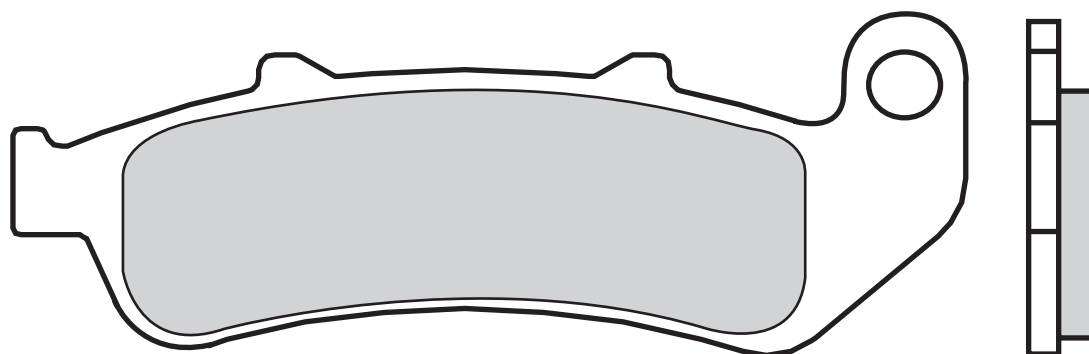

HONDA

1000 CBR F, FP 93 > 98 • •

1100 ST ABS-TCS-CBS 92 > 95 •





07HO40.08 79,9x41,9x 9,2
96,6x41,9x 9,2

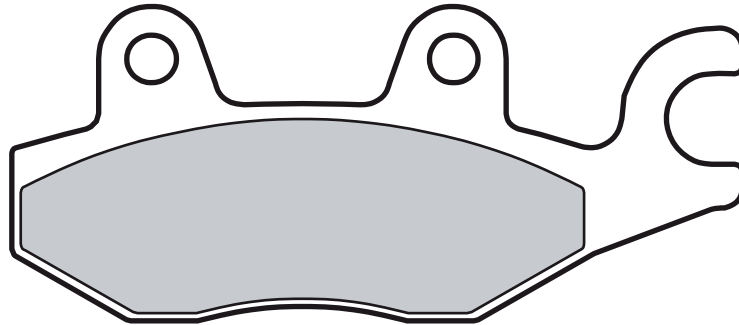
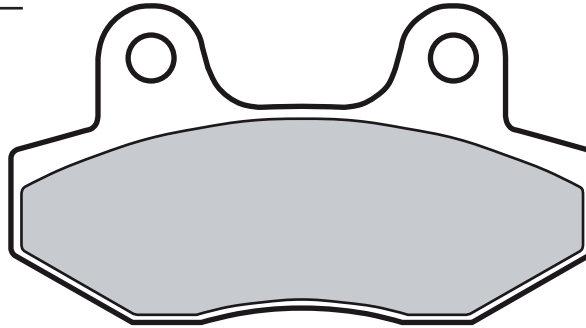

2

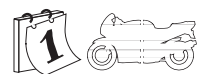
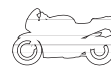
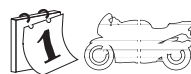
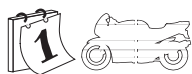
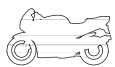

HONDA

125 VARADERO	01	•
125 VT SHADOW	99	•
150 NSR	02	•
250 CB F	04	•

ITALJET

50 ROLLERCRAFT	08	•
125 TORPEDO	08	•
150 TORPEDO	08	•





07H041.SA 102,1x38,9 x9,6

07H041.08 " " "

2

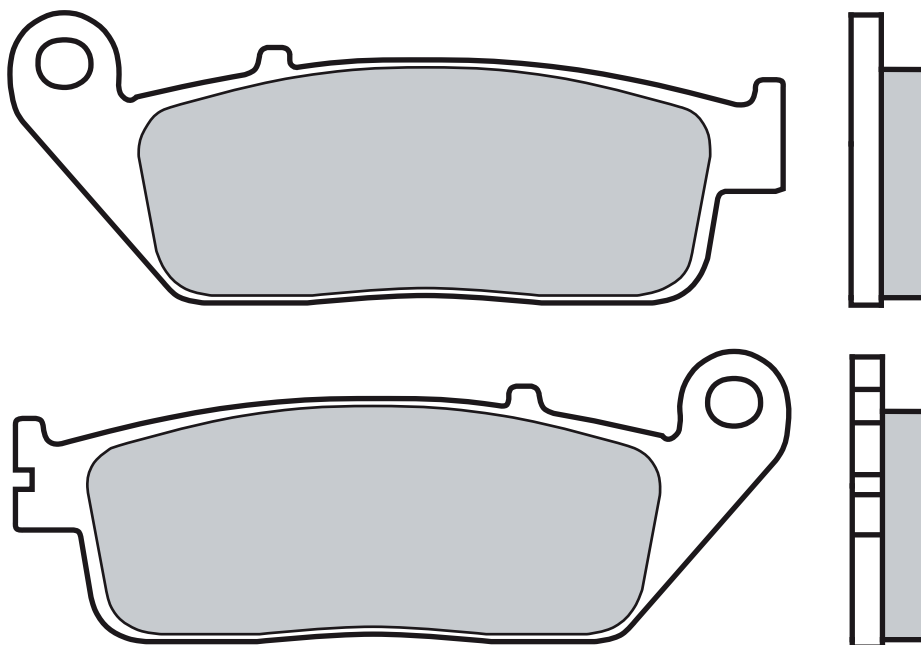

HONDA

500 CBF	04	•
600 XL V TRANSALP	94 > 96	•
750 BLACK WIDOW	01	•
750 SHADOW	04	•
750 VT C, SHADOW	97 > 03	•
750 VT SHADOW SPIRIT	07	•

1000 CBF	06	•
1000 CBF1000	09	•

TRIUMPH

900 ADVENTURER	95	•
900 THUNDERBIRD	95	•





07H042.SA 115x 40,1x8,3
07H042.06 " " "

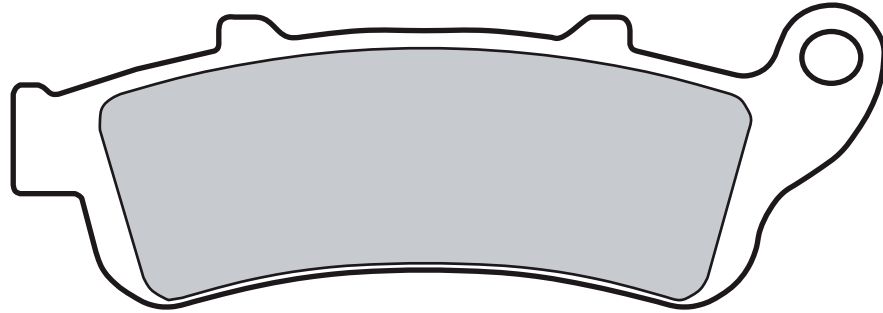

2

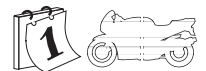
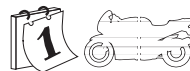
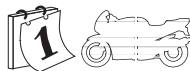
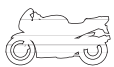

HONDA

650	NTV DEAUVILLE	03	•
800	VFR FI	98 > 01	•
800	VFR V-TEC ABS	02 > 05	•
1000	CBR XX	96	•

1000	VARADERO ABS	04	•
1000	XL VARADERO	99 > 03	•
1000	XL VARADERO (Linked Brake System)	00	•
1100	CB HORNET	99	•
1100	CB X-11	00	•

1100	ST	96	•
1300	STX PAN EUROPEAN	02	•
1800	GL GOLD WING	01	•
1800	VTX	01	•





07H043.SA 115x 40,1x 8,3

07H043.SP " " "

07H043.08 " " "

2

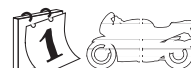
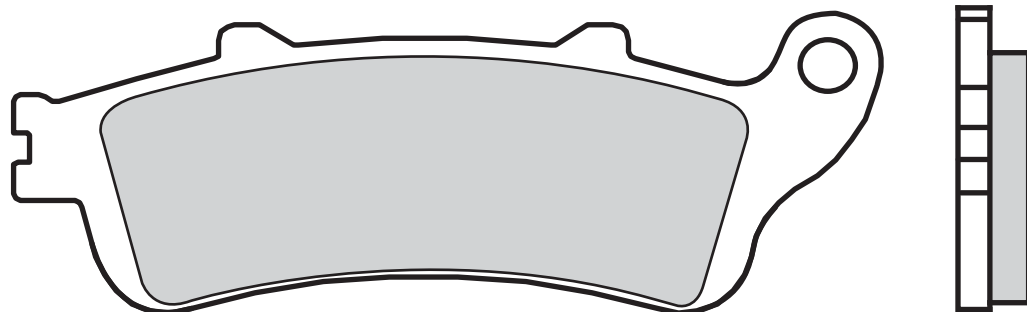

HONDA

650	NTV DEAUVILLE	03	•
700	NT DEAUVILLE ABS	06	•
800	VFR FI	98 > 01	•
800	VFR V-TEC ABS	02 > 05	•
800	VFR V-TEC ABS	06	•
1000	CBR XX	96	•

1000	VARADERO ABS	04	•
1000	XL VARADERO	99 > 03	•
1000	XL VARADERO (Linked Brake System)	00	•
1000	XLV VARADERO ABS	04	•
1000	XLV VARADERO TRAVEL ABS	04	•
1100	CB HORNET	99	•
1100	CB X-11	00	•

1100	ST	96	•
1300	STX PAN EUROPEAN	02	•
1300	VTX C	04	•
1800	GL GOLD WING	01	•
1800	VTX	01	•





07H045.SA	74,5x55,2x 7,2
07H045.07	" " "
07H045.SC	74,5x55,2x 8
07H045.RC	" " "

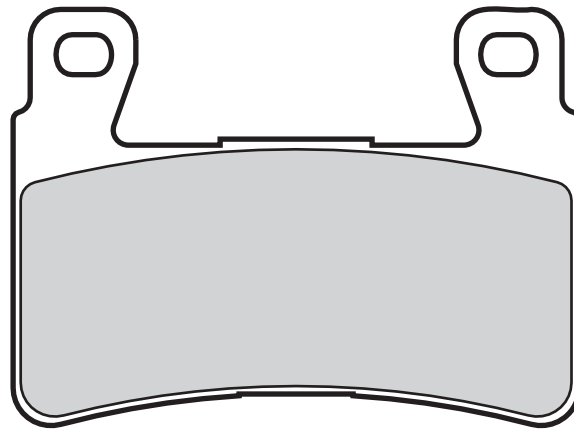

2

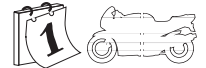
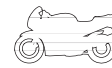
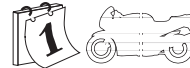
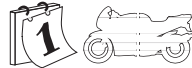

HONDA

600 CBR F4	99 > 02	•
600 CBR RR	03 > 04	•

900 CBR RR	98 > 99	•
900 CBR RR FIREBALDE (954 cc)	02 > 03	•
900 CBR RR FIREBLADE (929 cc)	00 > 01	•

1000 VTR SP01,SP02 (RC 51)	00	•
1300 CB R	02	•



07H046.07	75,1x 42x 8,1
------------------	---------------

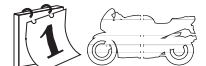
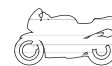
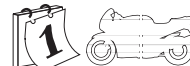
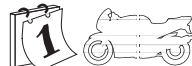
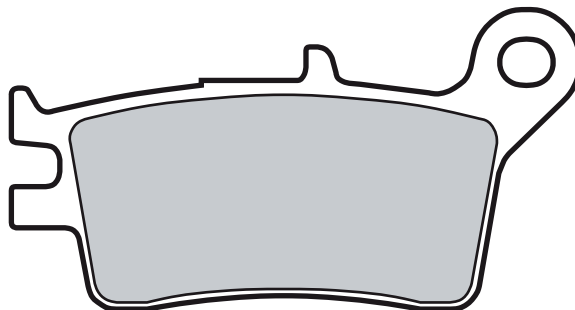
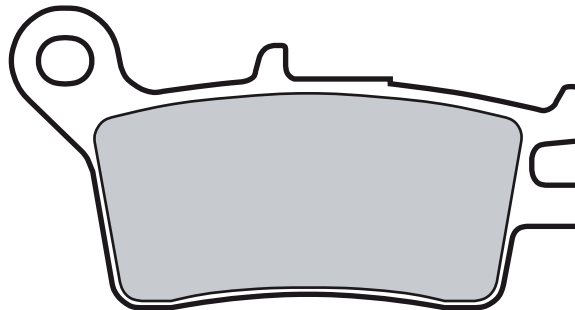

HONDA

220 TLM	89	•
260 TLM R	90	•





07H048.SD	59,7x43,7x9,5
07H048.SX	" " "
07H048.TT	" " "

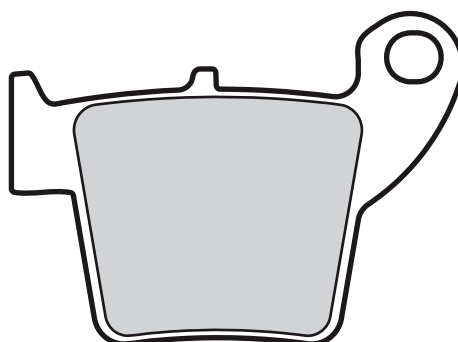
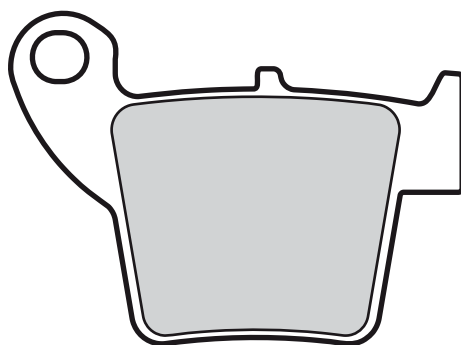

2

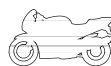
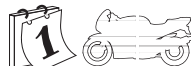
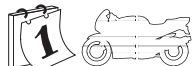

APRILIA

450 MX V	09	•
----------	----	---

HM

125 CR SUPERMOTARD	04	•
125 CRM X SUPERMOTARD 07 > 07		•
250 CRE F ENDURO	04	•
250 CRE R ENDURO	02	•
250 CRE X ENDURO	04	•
250 CRF X SUPERMOTARD	04	•
250 CRM X SUPERMOTARD	07	•

450 CRE F ENDURO	02	•
450 CRE X ENDURO	04	•
450 CRF F SUPERMOTARD	04	•
450 CRF SUPERMOTARD	02	•
450 CRF X SUPERMOTARD	04	•
450 CRM X SUPERMOTARD	07	•
500 CRM X SUPERMOTARD	07	•

HONDA

125 CR R, E	02	•
150 CRF R	07	•

250 CR E	02	•
250 CR R	02	•
250 CRE F	04	•
250 CRE X	04	•
250 CRF R	04	•
450 CRE F	02	•
450 CRF X	05	•
450 CRF, E	02	•
450 CRF450R	09	•
450 TRX X	04	•





07H049.05 106,7x42,4x10
91,4x 39,8x10

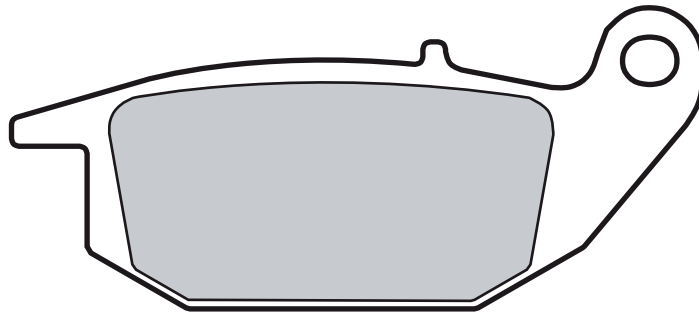
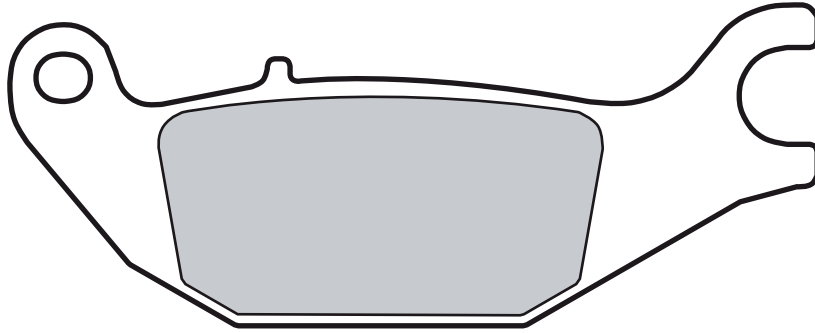

2

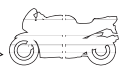
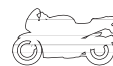

HONDA

125	CBR R	04	•
125	VARADERO	01	•
150	CBR R	00	•





07H050.SA 74,1x46,7x 8
07H050.SC 74,1x46,7x 9
07H050.RC " " "

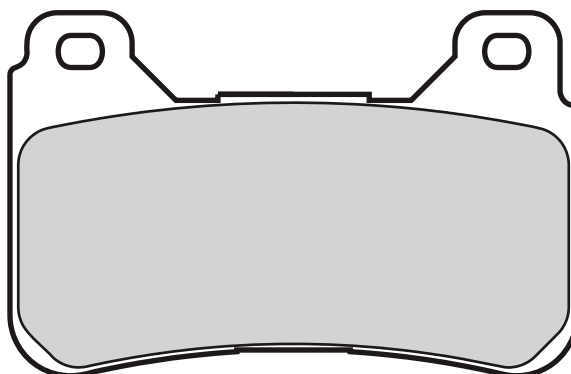

2

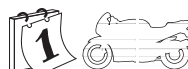
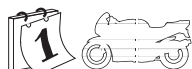

HONDA

600	CBR RR	05 > 06	•
600	CBR RR	07	•

600	CBR600RR	09	•
1000	CB R	08	•
1000	CBR RR	04 > 05	•

1000	CBR RR	06	•
1000	CBR1000RR FIREBLADE	09	•
1000	CBR1000RR FIREBLADE ABS	09	•



07H051.01 41,8x 50x 6,5

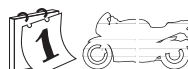
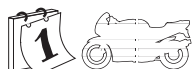
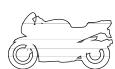
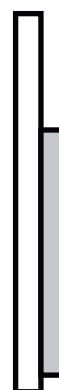
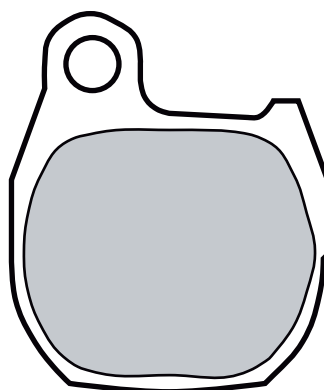

HONDA

220	TLM	89	•
260	TLM R	90	•





07H055.SD 75,3x 39,4x 9,7

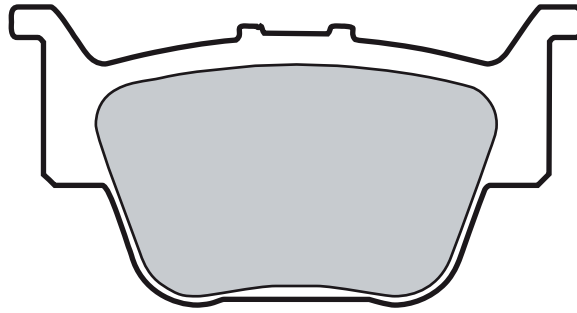

2

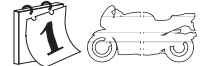
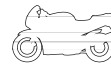
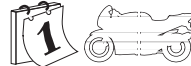
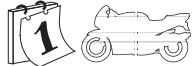
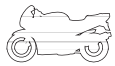

HONDA

420	TRX FA / FPA	09	•
450	TRX R	04	•

650	TRX FA Rincon	03 > 05	•
650	TRX FGA Rincon	04 > 05	•
680	TRX FA6 Rincon	06	•

680	TRX FGA6 Rincon	06	•
-----	-----------------	----	---



07H056.06 110,8x35,7x7,6
98,1x32,7x7,6

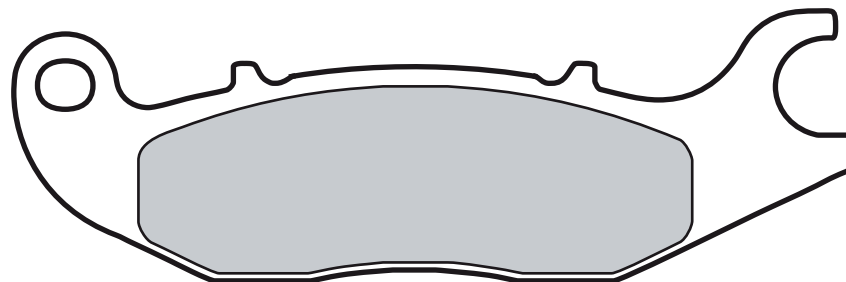
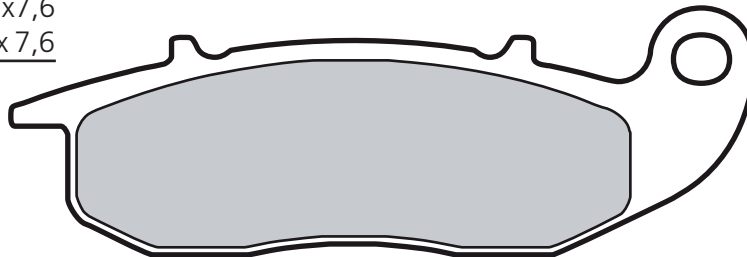

HONDA

125	ANF INNOVA	03	•
125	CBR R	04	•
150	CBR R	00	•

RIEJU

50	RS2 NKD	06	•
125	RS2 NKD	06	•





07H057.SA 117,6x44,9x 8,8

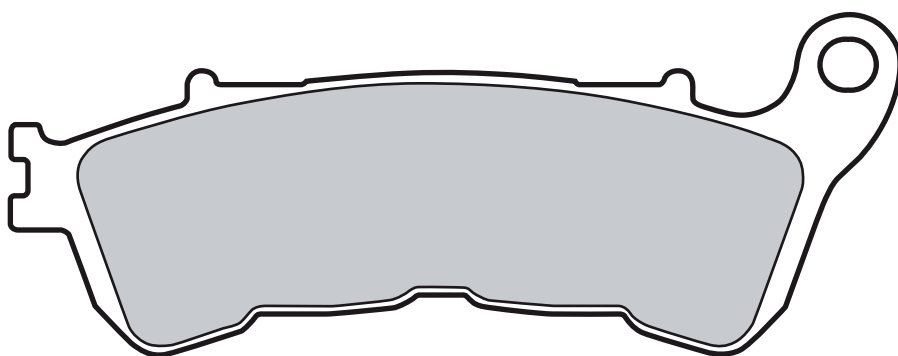
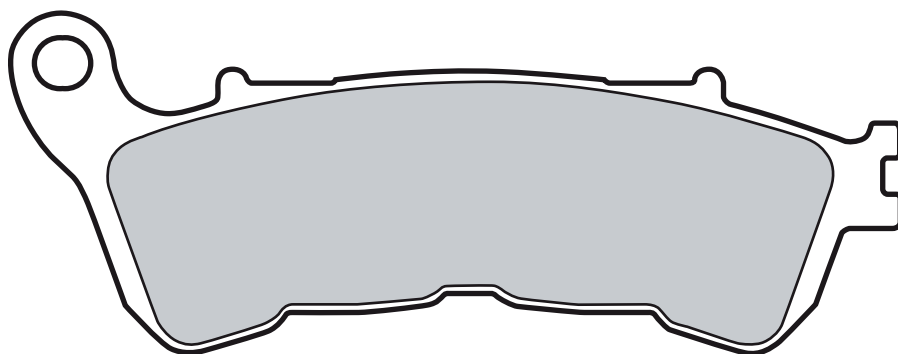

2

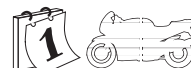
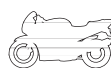
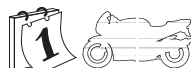
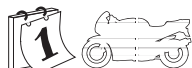

HONDA

500	CBF ABS	04	•
600	CBF	08	•
600	CBF N	08	•
600	CBF S	08	•
600	HORNET ABS	07	•
680	DN-01	08	•

700	NT DEAUVILLE ABS	06	•
700	XL TRANSALP	08	•
800	VFR V-TEC ABS	06	•
1000	CBF ABS	06	•
1000	CBF1000ST ABS	09	• •
1000	XLV VARADERO ABS	04	•
1000	XLV VARADERO TRAVEL ABS	04	•

SUZUKI

1800	C R Intruder	08	•
------	--------------	----	---





07H058.SD 81,4x38,9x 10,1

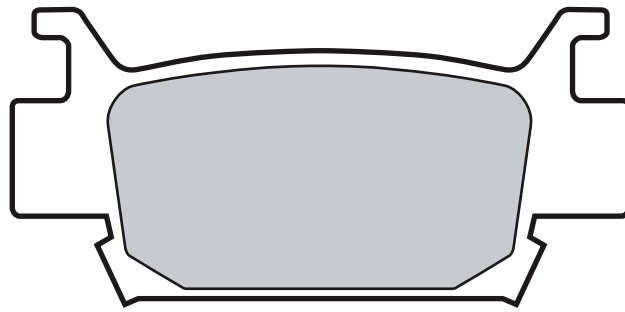

2

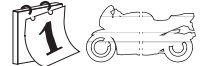
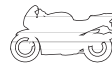
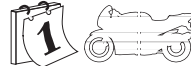
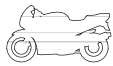
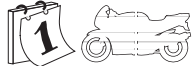
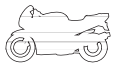

HONDA

500 TRX	05	•
700 TRX XX	08	•



07H059.SP 77,2x 41,7x 8,9
07H059.07 " " "

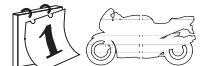
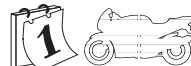
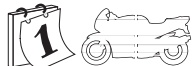
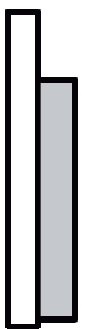
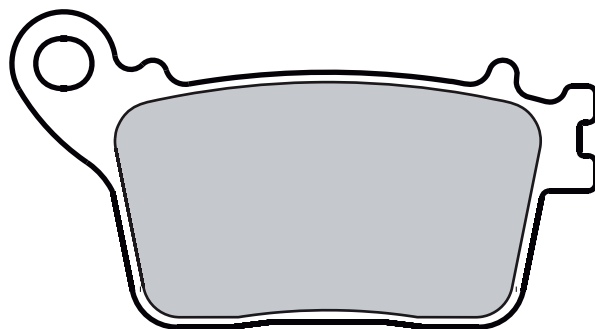

HONDA

600 CBR RR	07	•
600 CBR600RR	09	•

1000 CBR RR	06	•
1000 CBR1000RR FIREBLADE	09	•
1000 CBR1000RR FIREBLADE ABS	09	•

SUZUKI

1000 GSX R	09	•
------------	----	---

